

MINI KITCHEN



MINI & COMPACT

www.stengel-steelconcept.com



STENGENEL METAL KITCHENS - STEEL IN A BEAUTIFUL AND FUNCTIONAL DESIGN



2022/2023

stengel 
steel concept

You can download our mini kitchen catalogue, general information on our products, data sheets and operating instructions for our electrical appliances here:

www.stengel-steelconcept.com



stengel 
steel concept

CONTENTS

GENERAL INFORMATION	04	General information
Stengel mini kitchen - features & benefits	04	
Stengel mini kitchen - comparison	06	
MINI KITCHEN PREMIUMLINE MP	08	Premiumline MP
100/110 cm wide	16	
120 cm wide	18	
150 cm wide	20	
160 cm wide	22	
170 cm wide	24	
180 cm wide	26	
MINI KITCHEN KITCHENLINE MK	28	Kitchenline MK
90 cm wide	34	
100 cm wide	34	
120 cm wide	36	
150 cm wide	38	
MINI KITCHEN EASYLINE ME	40	Easyline ME
100 cm wide	42	
120 cm wide	43	
SET STUDIOLINE SL	44	Studioline SL
Studioline SLD - H2060	48	
Studioline SLD - H2220	48	
Studioline SLDH - H2220 with extractor	50	
CUPBOARD KITCHEN SKM	52	Cupboard Kitchen
basic model	54	
accessories	56	
larder cupboard	57	
CUPBOARDS HS/HO/HSMW/HOB	58	Cupboards
wall cupboards HS-H560	60	
wall cupboards HS-H720	62	
wall cupboards microwave HSMW 60	64	
larder cupboards HO 60	66	
larder cupboards with oven HOB 60	66	
ACCESSORIES / ELECTRICAL APPLIANCES	70	Appliances/Electric.
wall rack	68	
infill panels	70	
splashbacks / side cheeks	71	
accessories / taps	72	
electrical appliances	74	
INFORMATIONS	77	Informations
Stengel GmbH / partners / projects	77	
delivery / packaging	80	
connection scheme	82	

STENGENL MINI KITCHEN FEATURES & BENEFITS

We believe that a kitchen has to be able to do everything - regardless of size. If you have only little space at home, in your office or studio or place of work we have the mini kitchen that suits your needs.

Our **mini kitchens** will fulfill your requirements and wishes perfectly. Almost all models are delivered assembled and ready to plug in and cook.

Mini kitchen made from metal and its benefits:

We only use steel and stainless steel from European trade.

Powder coating

In a **Stengel kitchen**, powder-coated parts are constructed with our own state-of-the-art powder coating system. The coating makes the surfaces much more durable than ordinary liquid paint.

Stainless steel

We use stainless and acid-resistant stainless steel 1.4301 (X5CrNi18-10), which is approved for temperatures up to 600° Celsius, in our worktops, fronts and other parts.

Rust resistant

The stainless steel and powder-coated metal used in our products is resistant to water vapour, damp and other climatic influences - leaving no breeding ground for rust.

Easy to clean

Stengel mini kitchens are really easy to clean thanks to their smooth, non-porous surfaces.

Environmentally friendly

100% recyclable steel and no toxic substances mean we are making a vital contribution to both your health and the sustainable use of environmental resources. Eco-certification according to DIN EN 14001 is guaranteed.

Fire resistant

Steel kitchens never go up in flames, steel cannot self-ignite and does not provide any fuel for a fire.

Odourless

Powder-coated metal is odourless - even after thousands of hours of cooking, **Stengel kitchens** still smell fresh once cleaned, as the material does not absorb any foreign odours.

Advantages of metal Stengel mini kitchens compared to wooden kitchens:

- high durability
- no material deterioration compared to wood
- low installation costs
- simple installation
- timeless style
- no problems with damages caused by water
- space saving
- easy to maintain surfaces
- hygienic and anti-bacteria
- non-flammable / fire protection compliant



picture: MP100S in colour sand

COMPARISON OF KITCHEN MODELS

Our mini and compact kitchens have a wide range of applications. The kitchen that would be installed in a portacabin, for example, would be different to one installed in a holiday apartment. That's why we offer three different model series with different price points, features and designs.

MINI KITCHEN ME EASYLINE:

Features:

- Metal cupboard unit in powder coated finish, filled double-walled fronts
- Fridge with 2* -freezer, 48 cm wide
- Widths of 100 and 120 cm
- Deep drawn standard pantry tops with ventilation holes on top, integrated bowl, drainer and hobs – front mounted controls
- Hob: electric hotplates or without hotplates
- Metal cupboard unit without handles with push to open door
- Shelves as accessories
- Standard colour white



MINI KITCHEN MK KITCHENLINE:

Additional special features to ME Easyline:

- Fridge with 4* -freezer
- Widths of 90, 100, 120 und 150 cm
- Hob: electric hotplates, ceramic hob or without hob
- Metal handles in kitchen colour
- Available with microwave and oven (*1)
- Five additional colours (*2) - bordeaux, green apple, sand, mocha and black



MINI KITCHEN MP PREMIUMLINE:

Additional special features to MK Kitchenline:

- Metal covered fridge door
- Widths of 100, 110, 120, 150, 160, 170, 180 cm
- Premium pantry top made of brushed stainless steel with ventilation holes in front, built-in bowl with drainer, tap hole, filter basket and siphon
- Hob: ceramic hob, induction hob or without
- Modern bar handle in stainless steel
- Drawers (*1) with softclose
- Also with microwave with cooking function 20l and 30l, dishwasher, oven (*1)
- Two additional colours – slate grey and stainless steel



(*1) depending on the model (*2) for colored kitchens with metal covered fridge door

MP PREMIUMLINE MINI KITCHEN

FLEXIBLE AND FUNCTIONAL -
THE PERFECT KITCHEN FOR EVERYONES NEEDS

If style and functionality are of special value to you then the **Stengel Premiumline** range of kitchens is the perfect choice.

Our **mini kitchen** is made of powder coated sheet metal and supplied with double-walled doors which are filled with insulation to give strength and a solid feel. Classic design handles and high quality metal pull-out rails complete a perfect picture.

Classical or modern a style to meet everyones taste.

The **Premiumline** models become a fully-equipped kitchen by the option to choose from microwave, microwave oven with cooking function, dishwasher or oven. Available in the widths 100, 110, 120, 150, 160, 170 and 180 cm.

You can find more information about the **mini kitchen** on the following pages.





picture: MPM120A with HOB60 and HSPL120

MP PREMIUMLINE IN COLOUR

Fancy some colour?

Our fashionable colours allow you to create great design highlights or add a fresh splash of colour.

With coloured surfaces on all visible sides, our **mini kitchen** will make for a furnishing highlight in your home also on their own. Metal and stainless steel can create decorative contrasts even in combination with natural materials – such as wood.

Spoilt for choice: Matt or gloss, green, mocha, black or red...



BLACK MATT



GREEN APPLE



SAND MATT



picture: MPG160 with 2xHSP150 and HSMW

SLATE GREY



BORDEAUX



MOCHA METALLIC



STAINLESS STEEL

MODELS

MINI KITCHEN PREMIUMLINE



MP 100
see page 17



MPGS 110
see page 17



MPGS 120
see page 19



MP 100 S
see page 17



MP 120
see page 19



MPMOS 120
see page 19



MPM 100
see page 17



MP 120 A
see page 19



MP 150
see page 20



MP 110 S
see page 17



MPM 120 A
see page 19



MPM 150
see page 21



MPMOS 150
see page 21



MP 160
see page 22



MPGSMS3 160
see page 23



MPS4 150
see page 21



MPM 160
see page 23



MPB 160
see page 23



MPGS 150
see page 21



MPMOS 160
see page 23



MP 170
see page 24



MPGSM 150
see page 21



MPGS 160
see page 23



MPM 170
see page 25



MPB 150
see page 21



MPGSM 160
see page 23



MPMOS 170
see page 25

MODELS

MINI KITCHEN PREMIUMLINE



MPGSMOS 170
see page 25



MP 180 A
see page 26



MPGS 180 A
see page 27



MPGS 170
see page 25



MPM 180 A
see page 27



MPGSM 180 A
see page 27



MPGSM 170
see page 25



MPMOS 180 A
see page 27



MPB 180 A
see page 27



MPB 170
see page 25



MPGSMOS 180
see page 27



picture: MPGSMOS180 with 2xHSPL40, HSPL100 and 2xHO60 in colour black matt



picture: MPM 100 S - with hob

MINI KITCHEN PREMIUMLINE 100-110CM MP 100 - MP 110

- › Fridge 4*-freezer (standard) or without fridge(*)
- › Premium pantry top brushed and ground, built-in bowl Line 60, drain set and siphon, tap hole, with ceramic hob, induction hob or without hob
- › Metal cupboard unit in white powder coated finish, cupboards have no backs, drawers with softclose
- › Filled double-walled fronts, powder-coated, bar handle in stainless steel
- › Fridge with metal covered fridge door
- › Inclusive all listed electrical appliances
- › Available in eight different colours
- › Delivered assembled and ready to plug in

Top version



ceramic or
induction hob



without hob

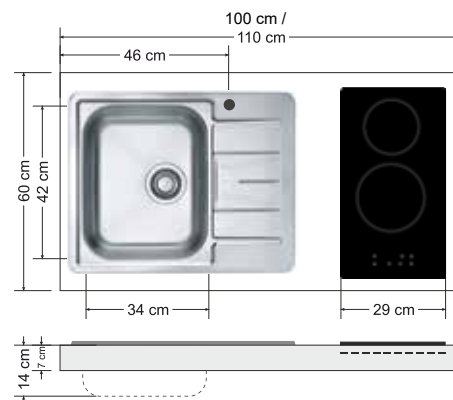

Colour Range Premiumline

stainless steel



01 - stainless steel

gloss powder coating

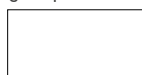

00 - white



03 - bordeaux



13 - green apple

matt powder coating



11 - sand



12 - black



14 - mocha metallic

structure
powder coating



15 - slate grey

article no.	colour	hob	bowlside
10100 000631 - XX	ceramic	ceramic	bowl right
10100 000641 - XX	ceramic	ceramic	bowl left
10100 000651 - XX	without	without	bowl right
10100 000661 - XX	without	without	bowl left
10100 000671 - XX	induction	induction	bowl right
10100 000681 - XX	induction	induction	bowl left

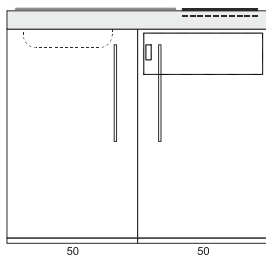

MP 100

fridge

dimensions: 100 x 60 x 89 cm (WxDxH)

article no.	colour	hob	bowlside
10100 100631 - XX	ceramic	ceramic	bowl right
10100 100641 - XX	ceramic	ceramic	bowl left
10100 100651 - XX	without	without	bowl right
10100 100661 - XX	without	without	bowl left
10100 100671 - XX	induction	induction	bowl right
10100 100681 - XX	induction	induction	bowl left

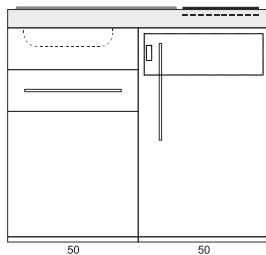

MP 100 S

fridge

one drawer

door in the sink cupboard with touch closure

dimensions: 100 x 60 x 89 cm (WxDxH)

article no.	colour	hob	bowlside
10100 010631 - XX	ceramic	ceramic	bowl right
10100 010641 - XX	ceramic	ceramic	bowl left
10100 010651 - XX	without	without	bowl right
10100 010661 - XX	without	without	bowl left
10100 010671 - XX	induction	induction	bowl right
10100 010681 - XX	induction	induction	bowl left

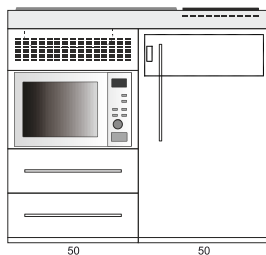

MPM 100

20l microwave

fridge

two drawers

dimensions: 100 x 60 x 89 cm (WxDxH)

article no.	colour	hob	bowlside
10110 102631 - XX	ceramic	ceramic	bowl right
10110 102641 - XX	ceramic	ceramic	bowl left
10110 102651 - XX	without	without	bowl right
10110 102661 - XX	without	without	bowl left
10110 102671 - XX	induction	induction	bowl right
10110 102681 - XX	induction	induction	bowl left

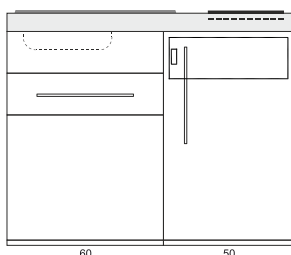

MP 110 S

fridge

one drawer

door in the sink cupboard with touch closure

dimensions: 110 x 60 x 89 cm (WxDxH)

article no.	colour	hob	bowlside
10110 680631 - XX	ceramic	ceramic	bowl right
10110 680641 - XX	ceramic	ceramic	bowl left
10110 680651 - XX	without	without	bowl right
10110 680661 - XX	without	without	bowl left
10110 680671 - XX	induction	induction	bowl right
10110 680681 - XX	induction	induction	bowl left

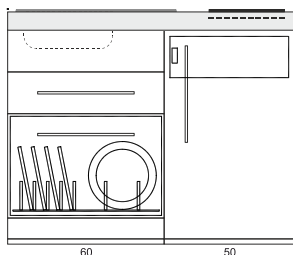

MPGS 110

dishwasher

fridge

one drawer

dimensions: 110 x 60 x 89 cm (WxDxH)



picture: MPM 120 A - with hob

MINI KITCHEN PREMIUMLINE 120CM MP 120

- > Fridge 4*-freezer (standard) or without fridge(*)
- > Premium pantry top brushed and ground, built-in bowl Line 60, drain set and siphon, tap hole, with ceramic hob, induction hob or without hob
- > Metal cupboard unit in white powder coated finish, cupboards have no backs, drawers with softclose
- > Filled double-walled fronts, powder-coated, bar handle in stainless steel
- > Fridge with metal covered fridge door
- > Inclusive all listed electrical appliances
- > Available in eight different colours
- > Delivered assembled and ready to plug in

Top version



ceramic or
induction hob



without hob

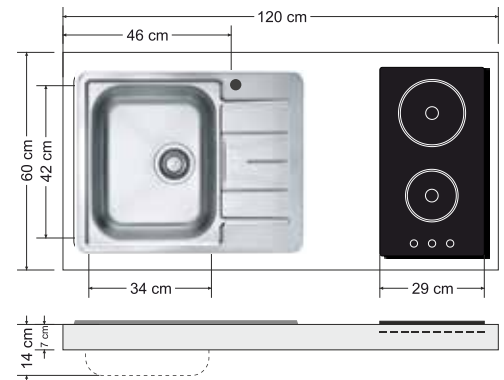

Colour Range Premiumline

stainless steel



01 - stainless steel

gloss powder coating

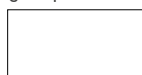

00 - white



03 - bordeaux



13 - green apple

matt powder coating



11 - sand



12 - black



14 - mocha metallic

structure
powder coating



15 - slate grey

article no.	colour	hob	bowlside
10120 001631 - XX	ceramic	ceramic	bowl right
10120 001641 - XX	ceramic	ceramic	bowl left
10120 001651 - XX	without	without	bowl right
10120 001661 - XX	without	without	bowl left
10120 001671 - XX	induction	induction	bowl right
10120 001681 - XX	induction	induction	bowl left

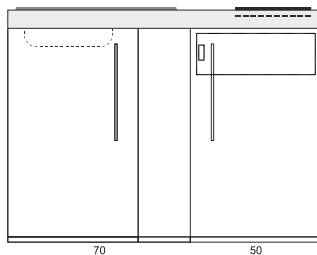

MP 120

fridge
2-door cupboard 50/20 cm

dimensions: 120 x 60 x 89 cm (WxDxH)

article no.	colour	hob	bowlside
10120 102631 - XX	ceramic	ceramic	bowl right
10120 102641 - XX	ceramic	ceramic	bowl left
10120 102651 - XX	without	without	bowl right
10120 102661 - XX	without	without	bowl left
10120 102671 - XX	induction	induction	bowl right
10120 102681 - XX	induction	induction	bowl left

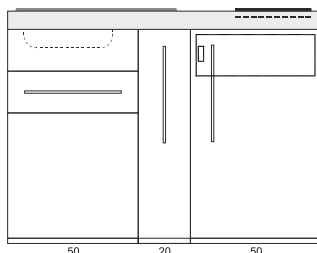

MP 120 A

fridge
pull out unit 20 cm with two trays
door in the sink
cupboard with touch closure
one drawer

dimensions: 120 x 60 x 89 cm (WxDxH)

article no.	colour	hob	bowlside
10120 012631 - XX	ceramic	ceramic	bowl right
10120 012641 - XX	ceramic	ceramic	bowl left
10120 012651 - XX	without	without	bowl right
10120 012661 - XX	without	without	bowl left
10120 012671 - XX	induction	induction	bowl right
10120 012681 - XX	induction	induction	bowl left

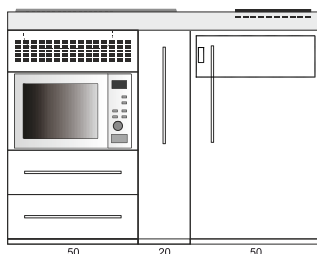

MPM 120 A

20l microwave
fridge
pull out unit 20 cm with two trays
two drawers

dimensions: 120 x 60 x 89 cm (WxDxH)

article no.	colour	hob	bowlside
10120 390631 - XX	ceramic	ceramic	bowl right
10120 390641 - XX	ceramic	ceramic	bowl left
10120 390651 - XX	without	without	bowl right
10120 390661 - XX	without	without	bowl left
10120 390671 - XX	induction	induction	bowl right
10120 390681 - XX	induction	induction	bowl left

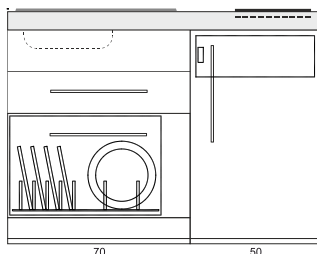

MPGS 120

dishwasher
fridge
one drawer

dimensions: 120 x 60 x 89 cm (WxDxH)

article no.	colour	hob	bowlside
10120 800631 - XX	ceramic	ceramic	bowl right
10120 800641 - XX	ceramic	ceramic	bowl left
10120 800651 - XX	without	without	bowl right
10120 800661 - XX	without	without	bowl left
10120 800671 - XX	induction	induction	bowl right
10120 800681 - XX	induction	induction	bowl left

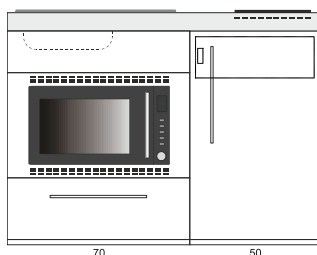

MPMOS 120

30l microwave /oven combination
fridge
one drawer

dimensions: 120 x 60 x 89 cm (WxDxH)



picture: MPMOS 150 - with hob

MINI KITCHEN PREMIUMLINE MP 150

- > Fridge 4*-freezer (standard) or without fridge(*)
- > Premium pantry top brushed and ground, built-in bowl Line 60, drain set and siphon, tap hole, with ceramic hob, induction hob or without hob
- > Metal cupboard unit in white powder coated finish, cupboards have no backs, drawers with softclose
- > Filled double-walled fronts, powder-coated, bar handle in stainless steel
- > Fridge with metal covered fridge door
- > Inclusive all listed electrical appliances
- > Available in eight different colours
- > Delivered assembled and ready to plug in

Top version



ceramic or
induction hob



without hob

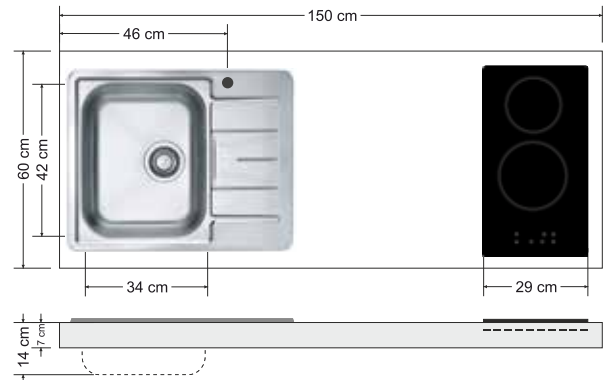

Colour Range Premiumline

stainless steel



01 - stainless steel

gloss powder coating



00 - white



03 - bordeaux



13 - green apple

matt powder coating



11 - sand



12 - black



14 - mocha metallic

structure
powder coating



15 - slate grey

article no.	colour	hob	bowl side
10150 100631 - XX		ceramic	bowl right
10150 100641 - XX		ceramic	bowl left
10150 100651 - XX		without	bowl right
10150 100661 - XX		without	bowl left
10150 100671 - XX		induction	bowl right
10150 100681 - XX		induction	bowl left

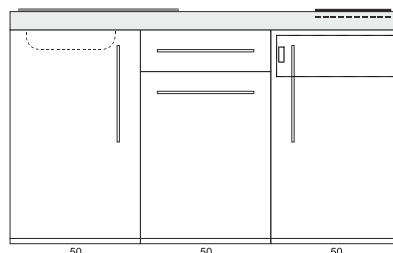

MP 150
fridge
one drawer

dimensions: 150 x 60 x 89 cm (WxDxH)

article no.	colour	hob	bowlside
10150 010631 - XX	ceramic	ceramic	bowl right
10150 010641 - XX	ceramic	ceramic	bowl left
10150 010651 - XX	without	without	bowl right
10150 010661 - XX	without	without	bowl left
10150 010671 - XX	induction	induction	bowl right
10150 010681 - XX	induction	induction	bowl left

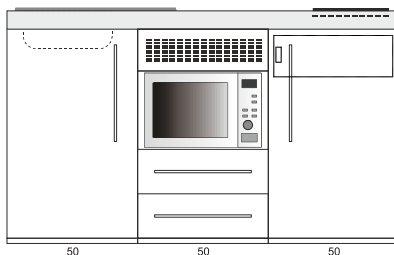

MPM 150

20l microwave
fridge
two drawers

dimensions: 150 x 60 x 89 cm (WxDxH)

article no.	colour	hob	bowlside
10150 809631 - XX	ceramic	ceramic	bowl right
10150 809641 - XX	ceramic	ceramic	bowl left
10150 809651 - XX	without	without	bowl right
10150 809661 - XX	without	without	bowl left
10150 809671 - XX	induction	induction	bowl right
10150 809681 - XX	induction	induction	bowl left

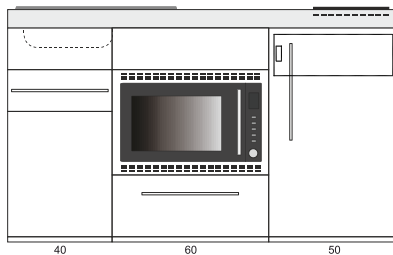

MPMOS 150

30l microwave /oven combination
fridge
door in the sink cupboard with touch closure
two drawers

dimensions: 150 x 60 x 89 cm (WxDxH)

article no.	colour	hob	bowlside
10150 004631 - XX	ceramic	ceramic	bowl right
10150 004641 - XX	ceramic	ceramic	bowl left
10150 004651 - XX	without	without	bowl right
10150 004661 - XX	ohne	ohne	Spüle links
10150 004671 - XX	induction	induction	bowl right
10150 004681 - XX	induction	induction	bowl left

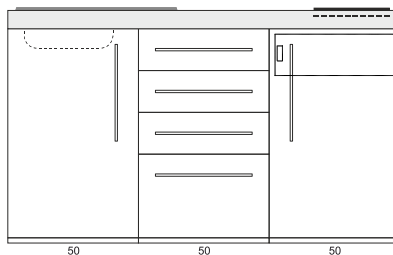

MPS4 150

fridge
four drawers

dimensions: 150 x 60 x 89 cm (WxDxH)

article no.	colour	hob	bowlside
10150 680631 - XX	ceramic	ceramic	bowl right
10150 680641 - XX	ceramic	ceramic	bowl left
10150 680651 - XX	without	without	bowl right
10150 680661 - XX	without	without	bowl left
10150 680671 - XX	induction	induction	bowl right
10150 680681 - XX	induction	induction	bowl left

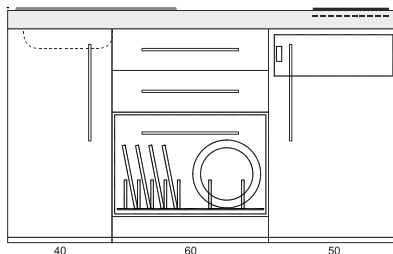

MPGS 150

dishwasher
fridge
two drawers

dimensions: 150 x 60 x 89 cm (WxDxH)

article no.	colour	hob	bowlside
10150 781631 - XX	ceramic	ceramic	bowl right
10150 781641 - XX	ceramic	ceramic	bowl left
10150 781651 - XX	without	without	bowl right
10150 781661 - XX	without	without	bowl left
10150 781671 - XX	induction	induction	bowl right
10150 781681 - XX	induction	induction	bowl left

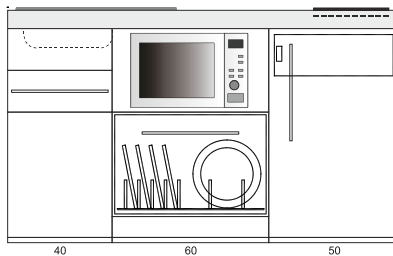

MPGSM 150

dishwasher
20l microwave
fridge
door in the sink cupboard with touch closure
one drawer

dimensions: 150 x 60 x 89 cm (WxDxH)

article no.	colour	hob	bowlside
10150 106631 - XX	ceramic	ceramic	bowl right
10150 106641 - XX	ceramic	ceramic	bowl left
10150 106651 - XX	without	without	bowl right
10150 106661 - XX	without	without	bowl left
10150 106671 - XX	induction	induction	bowl right
10150 106681 - XX	induction	induction	bowl left

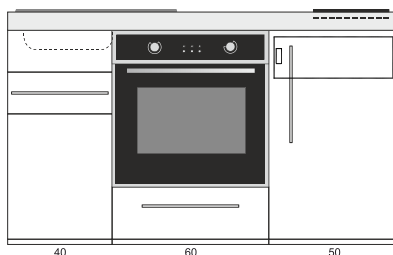

MPB 150

oven
fridge
door in the sink cupboard with touch closure
two drawers

dimensions: 150 x 60 x 89 cm (WxDxH)



picture: MPGSMS3 160 - with hob

MINI KITCHEN PREMIUMLINE MP 160

- > Fridge 4*-freezer (standard) or without fridge(*)
- > Premium pantry top brushed and ground, built-in bowl Line 60, drain set and siphon, tap hole, with ceramic hob, induction hob or without hob
- > Metal cupboard unit in white powder coated finish, cupboards have no backs, drawers with softclose
- > Filled double-walled fronts, powder-coated, bar handle in stainless steel
- > Fridge with metal covered fridge door
- > Inclusive all listed electrical appliances
- > Available in eight different colours
- > Delivered assembled and ready to plug in

Top version



ceramic or
induction hob



without hob

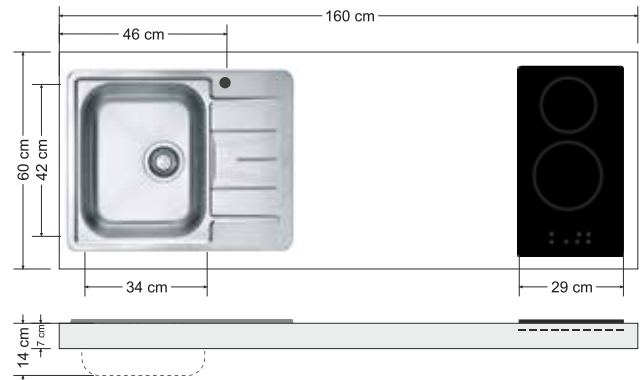

Colour Range Premiumline

stainless steel



01 - stainless steel

gloss powder coating



00 - white



03 - bordeaux



13 - green apple

matt powder coating



11 - sand



12 - black



14 - mocha metallic

structure
powder coating



15 - slate grey

article no.	colour	hob	bowl side
10160 080631 - XX		ceramic	bowl right
10160 080641 - XX		ceramic	bowl left
10160 080651 - XX		without	bowl right
10160 080661 - XX		without	bowl left
10160 080671 - XX		induction	bowl right
10160 080681 - XX		induction	bowl left

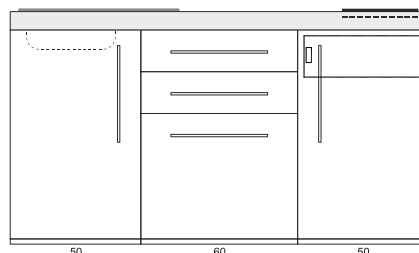

MP 160
fridge
two drawers

dimensions: 160 x 60 x 89 cm (WxDxH)

article no.	colour	hob	bowlside
10160 030631 - XX	ceramic	ceramic	bowl right
10160 030641 - XX	ceramic	ceramic	bowl left
10160 030651 - XX	without	without	bowl right
10160 030661 - XX	without	without	bowl left
10160 030671 - XX	induction	induction	bowl right
10160 030681 - XX	induction	induction	bowl left

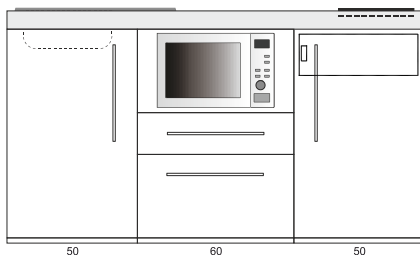

MPM 160

20l microwave
fridge
two drawers

dimensions: 160 x 60 x 89 cm (WxDxH)

article no.	colour	hob	bowlside
10160 809631 - XX	ceramic	ceramic	bowl right
10160 809641 - XX	ceramic	ceramic	bowl left
10160 809651 - XX	without	without	bowl right
10160 809661 - XX	without	without	bowl left
10160 809671 - XX	induction	induction	bowl right
10160 809681 - XX	induction	induction	bowl left

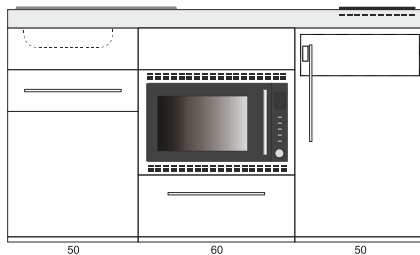

MPMOS 160

30l microwave /oven combination
fridge
door in the sink cupboard with touch closure
two drawers

dimensions: 160 x 60 x 89 cm (WxDxH)

article no.	colour	hob	bowlside
10160 680631 - XX	ceramic	ceramic	bowl right
10160 680641 - XX	ceramic	ceramic	bowl left
10160 680651 - XX	without	without	bowl right
10160 680661 - XX	without	without	bowl left
10160 680671 - XX	induction	induction	bowl right
10160 680681 - XX	induction	induction	bowl left

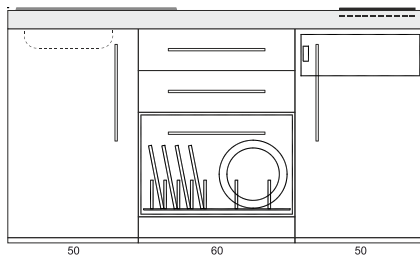

MPGS 160

dishwasher
fridge
two drawers

dimensions: 160 x 60 x 89 cm (WxDxH)

article no.	colour	hob	bowlside
10160 781631 - XX	ceramic	ceramic	bowl right
10160 781641 - XX	ceramic	ceramic	bowl left
10160 781651 - XX	without	without	bowl right
10160 781661 - XX	without	without	bowl left
10160 781671 - XX	induction	induction	bowl right
10160 781681 - XX	induction	induction	bowl left

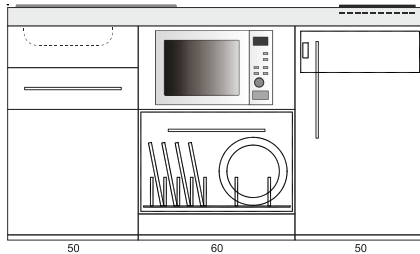

MPGSM 160

dishwasher
20l microwave
fridge
door in the sink cupboard with touch closure
one drawer

dimensions: 160 x 60 x 89 cm (WxDxH)

article no.	colour	hob	bowlside
10160 783631 - XX	ceramic	ceramic	bowl right
10160 783641 - XX	ceramic	ceramic	bowl left
10160 783651 - XX	without	without	bowl right
10160 783661 - XX	without	without	bowl left
10160 783671 - XX	induction	induction	bowl right
10160 783681 - XX	induction	induction	bowl left

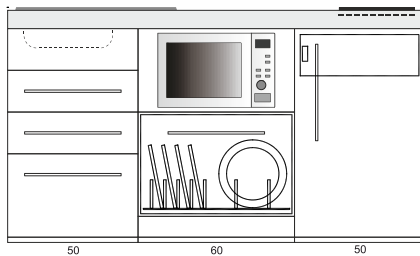

MPGSM S3 160

dishwasher
20l microwave
fridge
three drawers

dimensions: 160 x 60 x 89 cm (WxDxH)

article no.	colour	hob	bowlside
10160 106631 - XX	ceramic	ceramic	bowl right
10160 106641 - XX	ceramic	ceramic	bowl left
10160 106651 - XX	without	without	bowl right
10160 106661 - XX	without	without	bowl left
10160 106671 - XX	induction	induction	bowl right
10160 106681 - XX	induction	induction	bowl left

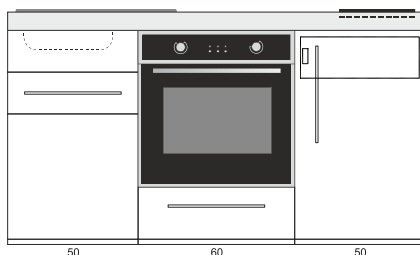

MPB 160

oven
fridge
door in the sink cupboard with touch closure
two drawers

dimensions: 160 x 60 x 89 cm (WxDxH)



picture: MPB 170 - with hob

MINI KITCHEN PREMIUMLINE MP 170

- > Fridge 4*-freezer (standard) or without fridge(*)
- > Premium pantry top brushed and ground, built-in bowl Line 60, drain set and siphon, tap hole, with ceramic hob, induction hob or without hob
- > Metal cupboard unit in white powder coated finish, cupboards have no backs, drawers with softclose
- > Filled double-walled fronts, powder-coated, bar handle in stainless steel
- > Fridge with metal covered fridge door
- > Inclusive all listed electrical appliances
- > Available in eight different colours
- > Delivered assembled and ready to plug in

Top version



ceramic or
induction hob



without hob

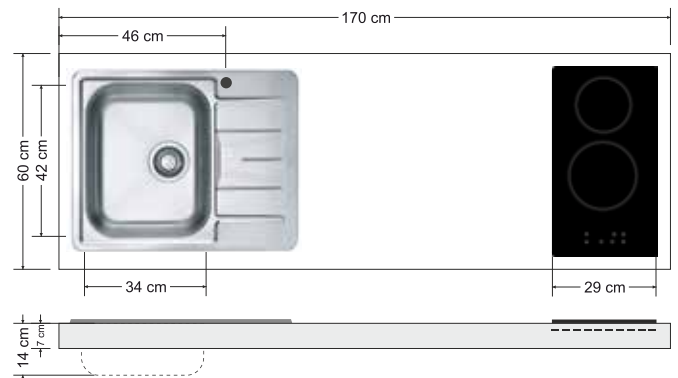

Colour Range Premiumline

stainless steel



01 - stainless steel

gloss powder coating

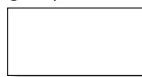

00 - white



03 - bordeaux



13 - green apple

matt powder coating



11 - sand



12 - black



14 - mocha metallic

structure
powder coating



15 - slate grey

article no.	colour	hob	bowlside
10170 080631 - XX		ceramic	bowl right
10170 080641 - XX		ceramic	bowl left
10170 080651 - XX		without	bowl right
10170 080661 - XX		without	bowl left
10170 080671 - XX		induction	bowl right
10170 080681 - XX		induction	bowl left

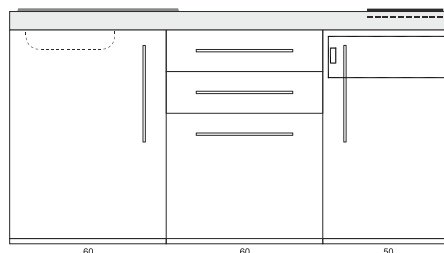

MP 170
fridge
two drawers

dimensions: 170 x 60 x 89 cm (WxDxH)

article no.	colour	hob	bowlside
10170 030631 - XX	ceramic	ceramic	bowl right
10170 030641 - XX	ceramic	without	bowl left
10170 030651 - XX	without	without	bowl right
10170 030661 - XX	without	without	bowl left
10170 030671 - XX	induction	induction	bowl right
10170 030681 - XX	induction	without	bowl left

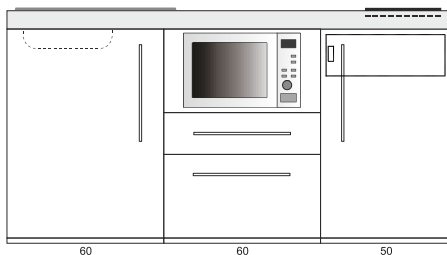

MPM 170

20l microwave
fridge
two drawers

dimensions: 170 x 60 x 89 cm (WxDxH)

article no.	colour	hob	bowlside
10170 809631 - XX	ceramic	ceramic	bowl right
10170 809641 - XX	ceramic	without	bowl left
10170 809651 - XX	without	without	bowl right
10170 809661 - XX	without	without	bowl left
10170 809671 - XX	induction	induction	bowl right
10170 809681 - XX	induction	without	bowl left

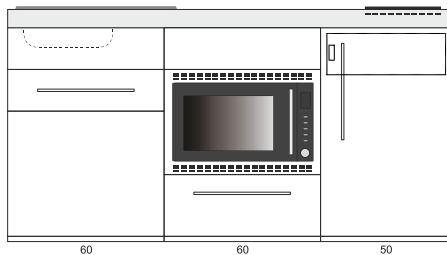

MPMOS 170

30l microwave /oven combination
fridge
door in the sink cupboard with touch closure
two drawers

dimensions: 170 x 60 x 89 cm (WxDxH)

article no.	colour	hob	bowlside
10170 880631 - XX	ceramic	ceramic	bowl right
10170 880641 - XX	ceramic	without	bowl left
10170 880651 - XX	without	without	bowl right
10170 880661 - XX	ohne	ohne	Spüle links
10170 880671 - XX	induction	induction	bowl right
10170 880681 - XX	induction	without	bowl left

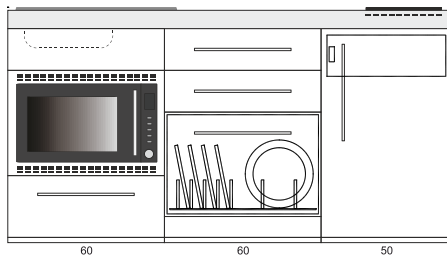

MPGSMOS 170

dishwasher
30l microwave /oven combination
fridge
three drawers

dimensions: 170 x 60 x 89 cm (WxDxH)

article no.	colour	hob	bowlside
10170 680631 - XX	ceramic	ceramic	bowl right
10170 680641 - XX	ceramic	without	bowl left
10170 680651 - XX	without	without	bowl right
10170 680661 - XX	without	without	bowl left
10170 680671 - XX	induction	induction	bowl right
10170 680681 - XX	induction	without	bowl left

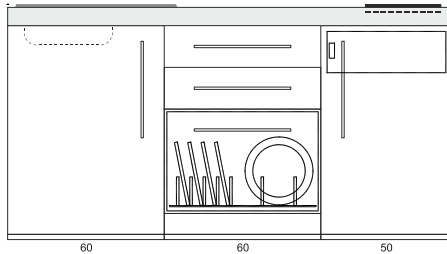

MPGS 170

dishwasher
fridge
two drawers

dimensions: 170 x 60 x 89 cm (WxDxH)

Artikel-Nr	Farbe	Kochfeld	Beckenseite
10170 781631 - XX	ceramic	ceramic	bowl right
10170 781641 - XX	ceramic	without	bowl left
10170 781651 - XX	without	without	bowl right
10170 781661 - XX	without	without	bowl left
10170 781671 - XX	induction	induction	bowl right
10170 781681 - XX	induction	without	bowl left

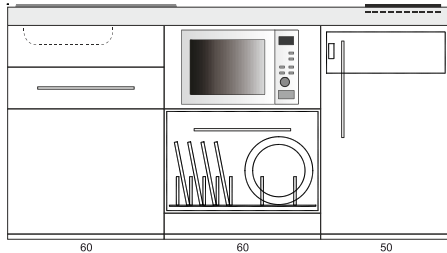

MPGSM 170

dishwasher
20l microwave
fridge
door in the sink cupboard with touch closure
one drawer

dimensions: 170 x 60 x 89 cm (WxDxH)

Artikel-Nr	Farbe	Kochfeld	Beckenseite
10170 106631 - XX	ceramic	ceramic	bowl right
10170 106641 - XX	ceramic	without	bowl left
10170 106651 - XX	without	without	bowl right
10170 106661 - XX	without	without	bowl left
10170 106671 - XX	induction	induction	bowl right
10170 106681 - XX	induction	without	bowl left

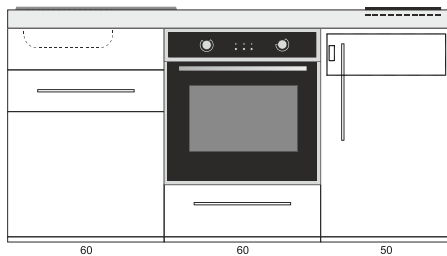

MPB 170

oven
fridge
door in the sink cupboard with touch closure
two drawers

dimensions: 170 x 60 x 89 cm (WxDxH)



picture: MPM 180 A - with hob

MINI KITCHEN PREMIUMLINE MP 180

- > Fridge 4*-freezer (standard) or without fridge(*)
- > Premium pantry top brushed and ground, built-in bowl Line 60, drain set and siphon, tap hole, with ceramic hob, induction hob or without hob
- > Metal cupboard unit in white powder coated finish, cupboards have no backs, drawers with softclose
- > Filled double-walled fronts, powder-coated, bar handle in stainless steel
- > Fridge with metal covered fridge door
- > Inclusive all listed electrical appliances
- > Available in eight different colours
- > Delivered assembled and ready to plug in

Top version



ceramic or
induction hob



without hob

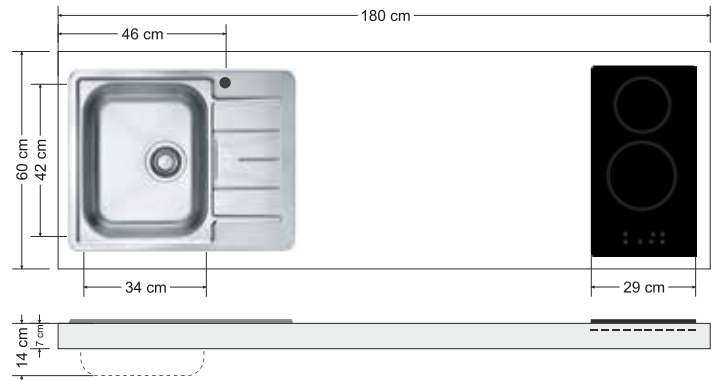

Colour Range Premiumline

stainless steel



01 - stainless steel

gloss powder coating



00 - white



03 - bordeaux



13 - green apple

matt powder coating



11 - sand



12 - black



14 - mocha metallic

structure
powder coating



15 - slate grey

article no.	colour	hob	bowl side
10180 082631 - XX		ceramic	bowl right
10180 082641 - XX		ceramic	bowl left
10180 082651 - XX		without	bowl right
10180 082661 - XX		without	bowl left
10180 082671 - XX		induction	bowl right
10180 082681 - XX		induction	bowl left

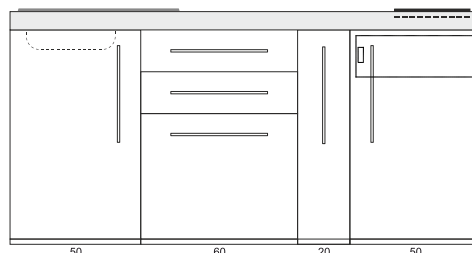

MP 180 A

fridge
pull out unit 20 cm with two trays
two drawers

dimensions: 180 x 60 x 89 cm (WxDxH)

article no.	colour	hob	bowlside
10180 032631 - XX	ceramic	ceramic	bowl right
10180 032641 - XX	ceramic	without	bowl left
10180 032651 - XX	without	without	bowl right
10180 032661 - XX	without	without	bowl left
10180 032671 - XX	induction	induction	bowl right
10180 032681 - XX	induction	without	bowl left

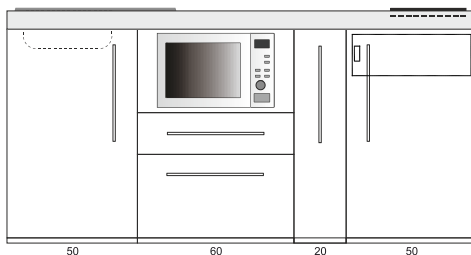

MPM 180 A

20l microwave
fridge
pull out unit 20 cm with two trays
two drawers

dimensions: 180 x 60 x 89 cm (WxDxH)

article no.	colour	hob	bowlside
10180 809631 - XX	ceramic	ceramic	bowl right
10180 809641 - XX	ceramic	without	bowl left
10180 809651 - XX	without	without	bowl right
10180 809661 - XX	without	without	bowl left
10180 809671 - XX	induction	induction	bowl right
10180 809681 - XX	induction	without	bowl left

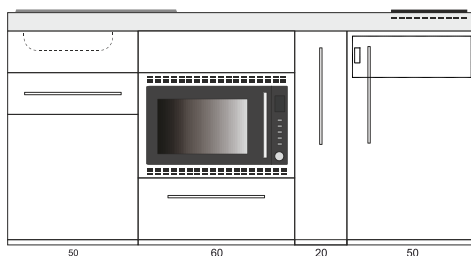

MPMOS 180 A

30l microwave /oven combination
fridge
pull out unit 20 cm with two trays
door in the sink cupboard with touch closure
two drawers

dimensions: 180 x 60 x 89 cm (WxDxH)

article no.	colour	hob	bowlside
10180 880631 - XX	ceramic	ceramic	bowl right
10180 880641 - XX	ceramic	without	bowl left
10180 880651 - XX	without	without	bowl right
10180 880661 - XX	without	without	bowl left
10180 880671 - XX	induction	induction	bowl right
10180 880681 - XX	induction	without	bowl left

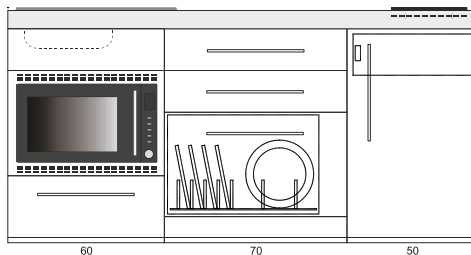

MPGSMOS 180

dishwasher
30l microwave /oven combination
fridge
three drawers

dimensions: 180 x 60 x 89 cm (WxDxH)

article no.	colour	hob	bowlside
10180 682631 - XX	ceramic	ceramic	bowl right
10180 682641 - XX	ceramic	without	bowl left
10180 682651 - XX	without	without	bowl right
10180 682661 - XX	without	without	bowl left
10180 682671 - XX	induction	induction	bowl right
10180 682681 - XX	induction	without	bowl left

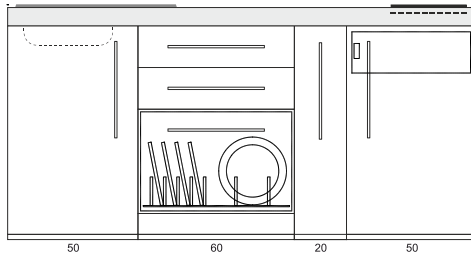

MPGS 180 A

dishwasher
fridge
pull out unit 20 cm with two trays
two drawers

dimensions: 180 x 60 x 89 cm (WxDxH)

article no.	colour	hob	bowlside
10180 782631 - XX	ceramic	ceramic	bowl right
10180 782641 - XX	ceramic	without	bowl left
10180 782651 - XX	without	without	bowl right
10180 782661 - XX	without	without	bowl left
10180 782671 - XX	induction	induction	bowl right
10180 782681 - XX	induction	without	bowl left

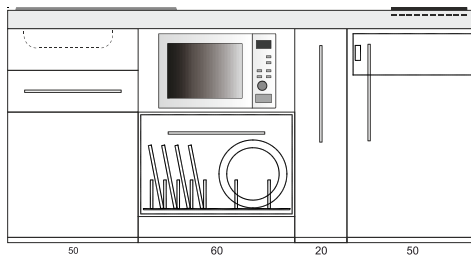

MPGSM 180 A

dishwasher
20l microwave
fridge
pull out unit 20 cm with two trays
door in the sink cupboard with touch closure
one drawer

dimensions: 180 x 60 x 89 cm (WxDxH)

article no.	colour	hob	bowlside
10180 162631 - XX	ceramic	ceramic	bowl right
10180 162641 - XX	ceramic	without	bowl left
10180 162651 - XX	without	without	bowl right
10180 162661 - XX	without	without	bowl left
10180 162671 - XX	induction	induction	bowl right
10180 162681 - XX	induction	without	bowl left

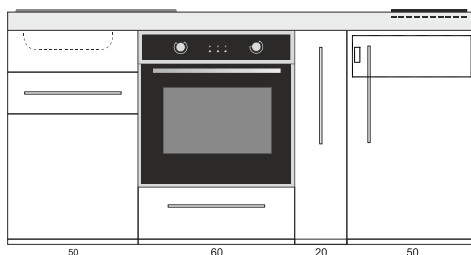

MPB 180 A

oven
fridge
pull out unit 20 cm with two trays
door in the sink cupboard with touch closure
two drawers

dimensions: 180 x 60 x 89 cm (WxDxH)

MK KITCHENLINE

MINI KITCHEN

COMPACT AND PERFECT - OUR ENTRY KITCHEN
MADE OF METAL AND FINISHED IN POWDER
COATED STEEL

If you are looking for quality for a small price then a **Stengel Kitchenline** is made for you. Sink, hotplates, fridge, storage space, microwave, dishwasher - all compact and in one **mini kitchen**.

Kitchenline is made of powder coated metal and is equipped with insulated, double-walled doors. **Kitchenline** is available in seven widths 90, 100, 120 and 150 cm.

Please discover the many combinations in the following pages.





picture: MKB150 with ceramic hotplates and HSCL150

MK KITCHENLINE IN COLOUR

Fancy some colour?

Our fashionable colours allow you to create great design highlights or add a fresh splash of colour.

With coloured surfaces on all visible sides, our **mini kitchen** will make for a furnishing highlight in your home also on their own. Metal and stainless steel can create decorative contrasts even in combination with natural materials – such as wood.

Spoilt for choice: Matt or gloss, green, mocha, black or red...





GREEN APPLE

picture: MKM120 with electrical hotplates and HSCL120

MODELS

KITCHENLINE MK



MK 90
see page 35



MK 120
see page 37



MK 150
see page 39



MK 100
see page 35



MK 120 A
see page 37



MKM 150
see page 39



MKM 100
see page 35



MKM 120
see page 37



MKB 150
see page 39



MKB 100
see page 35



MKM 120 A
see page 37



Kitchenline MK

picture: MK90 with electrical hotplates



picture: MK 100 with electric hotplates

MINI KITCHEN KITCHENLINE 90-100CM MK 90 - 100

- > Fridge 4*-freezer (standard) or without fridge(*)
- > Pantry top in stainless steel, hob controls on the front, bowl, drain set, 35mm hole for tap, a choice of solid hotplates, ceramic hob or without hob
- > Metal cupboard unit in white powder coated finish
- > Filled double-walled fronts, powder-coated, standard handle
- > Kitchen in colour white: There is a slight colour difference between fridge front and base structure
- > Within all mentioned electrical appliances
- > Available in six different colours
- > Delivered assembled and ready to plug in

Top version



electric hotplates



ceramic hob



without hob

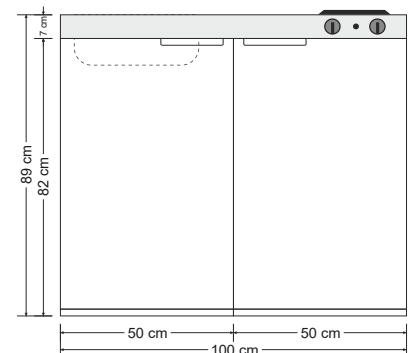
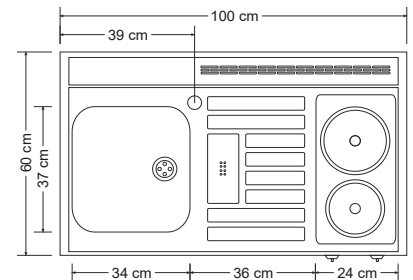

Colour Range Kitchenline

stainless steel



01 - stainless steel

gloss powder coating

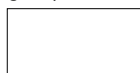

00 - white



03 - bordeaux



13 - green apple

matt powder coating



11 - sand



12 - black



14 - mocha metallic

structure powder coating



15 - slate grey

article no.	colour	hob	bowlside
11090 000011 - XX		electric	bowl right
11090 000021 - XX		electric	bowl left
11090 000031 - XX		ceramic	bowl right
11090 000041 - XX		ceramic	bowl left
11090 000051 - XX		without	bowl right
11090 000061 - XX		without	bowl left

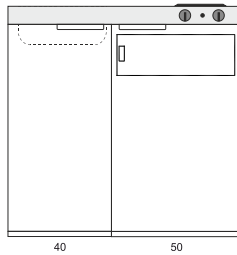

MK 90

fridge

dimensions: 90 x 60 x 89 cm (WxDxH)

article no.	colour	hob	bowlside
11100 000011 - XX		electric	bowl right
11100 000021 - XX		electric	bowl left
11100 000031 - XX		ceramic	bowl right
11100 000041 - XX		ceramic	bowl left
11100 000051 - XX		without	bowl right
11100 000061 - XX		without	bowl left

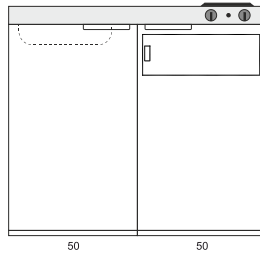

MK 100

fridge

dimensions: 100 x 60 x 89 cm (WxDxH)

article no.	colour	hob	bowlside
11100 010011 - XX		electric	bowl right
11100 010021 - XX		electric	bowl left
11100 010031 - XX		ceramic	bowl right
11100 010041 - XX		ceramic	bowl left
11100 010051 - XX		without	bowl right
11100 010061 - XX		without	bowl left

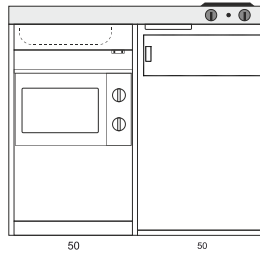

MKM 100

microwave, located behind the door
fridge

dimensions: 100 x 60 x 89 cm (WxDxH)

article no.	colour	hob	bowlside
11100 006010 - XX		electric	bowl right
11100 006020 - XX		electric	bowl left
11100 006030 - XX		ceramic	bowl right
11100 006040 - XX		ceramic	bowl left
11100 006050 - XX		without	bowl right
11100 006060 - XX		without	bowl left

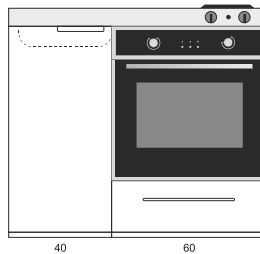

MKB 100

oven
cupboard 40cm, without fridge
one drawer

dimensions: 100 x 60 x 89 cm (WxDxH)



picture: MKM 120 A - with ceramic hobs

MINI KITCHEN KITCHENLINE 120CM MK 120

- > Fridge 4*-freezer (standard) or without fridge(*)
- > Pantry top in stainless steel, hob controls on the front, bowl, drain set, 35mm hole for tap, a choice of solid hotplates, ceramic hob or without hob
- > Metal cupboard unit in white powder coated finish
- > Filled double-walled fronts, powder-coated, standard handle
- > Kitchen in colour white: There is a slight colour difference between fridge front and base structure
- > Within all mentioned electrical appliances
- > Available in six different colours
- > Delivered assembled and ready to plug in

Top version



electric hotplates



ceramic hob



without hob

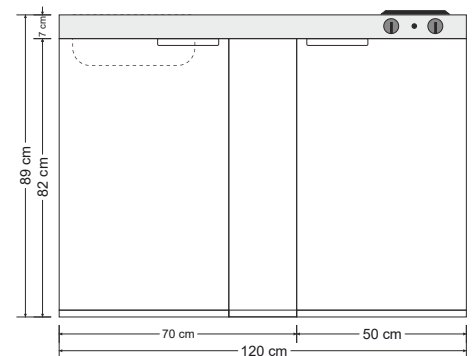
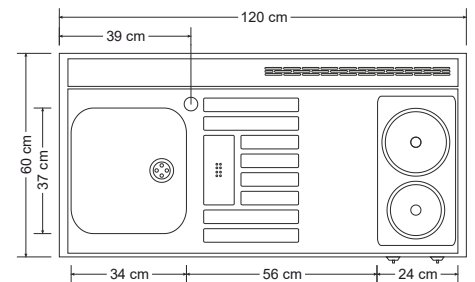

Colour Range Kitchenline

stainless steel



01 - stainless steel

gloss powder coating

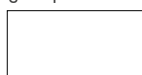

00 - white



03 - bordeaux



13 - green apple

matt powder coating



11 - sand



12 - black



14 - mocha metallic

structure powder coating



15 - slate grey

article no.	colour	hob	bowlside
11120 001011 - XX		electric	bowl right
11120 001021 - XX		electric	bowl left
11120 001031 - XX		ceramic	bowl right
11120 001041 - XX		ceramic	bowl left
11120 001051 - XX		without	bowl right
11120 001061 - XX		without	bowl left

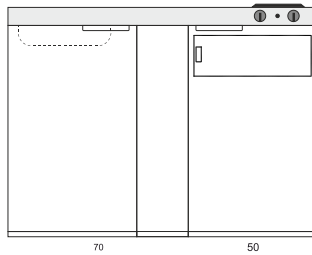

MK 120

fridge
2-door cupboard 50/20 cm

dimensions: 120 x 60 x 89 cm (WxDxH)

article no.	colour	hob	bowlside
11120 002011 - XX		electric	bowl right
11120 002021 - XX		electric	bowl left
11120 002031 - XX		ceramic	bowl right
11120 002041 - XX		ceramic	bowl left
11120 002051 - XX		without	bowl right
11120 002061 - XX		without	bowl left

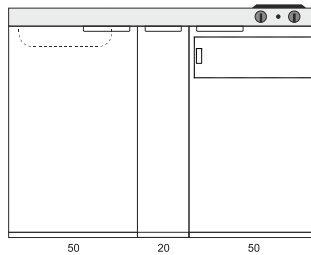

MK 120 A

fridge
pull out unit 20 cm with two trays

dimensions: 120 x 60 x 89 cm (WxDxH)

article no.	colour	hob	bowlside
11120 011011 - XX		electric	bowl right
11120 011021 - XX		electric	bowl left
11120 011031 - XX		ceramic	bowl right
11120 011041 - XX		ceramic	bowl left
11120 011051 - XX		without	bowl right
11120 011061 - XX		without	bowl left

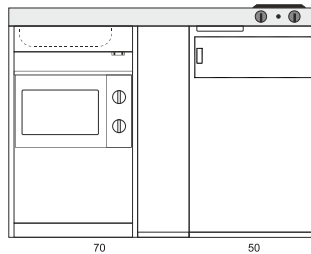

MKM 120

microwave, located behind the door
fridge
2-door cupboard 50/20 cm

dimensions: 120 x 60 x 89 cm (WxDxH)

article no.	colour	hob	bowlside
11120 012011 - XX		electric	bowl right
11120 012021 - XX		electric	bowl left
11120 012031 - XX		ceramic	bowl right
11120 012041 - XX		ceramic	bowl left
11120 012051 - XX		without	bowl right
11120 012061 - XX		without	bowl left

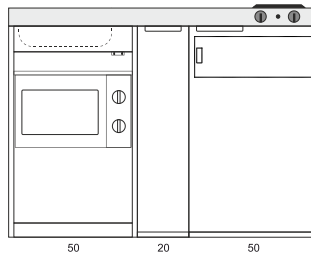

MKM 120 A

microwave, located behind the door
fridge
pull out unit 20 cm with two trays

dimensions: 120 x 60 x 89 cm (WxDxH)



picture: MKB 150 - without hotplates

MINI KITCHEN KITCHENLINE 150CM MK 150

- > Fridge 4*-freezer (standard) or without fridge(*)
- > Pantry top in stainless steel, hob controls on the front, bowl, drain set, 35mm hole for tap, a choice of solid hotplates, ceramic hob or without hob
- > Metal cupboard unit in white powder coated finish
- > Filled double-walled fronts, powder-coated, standard handle
- > Kitchen in colour white: There is a slight colour difference between fridge front and base structure
- > Within all mentioned electrical appliances
- > Available in six different colours
- > Delivered assembled and ready to plug in

Top version



electric hotplates



ceramic hob



without hob

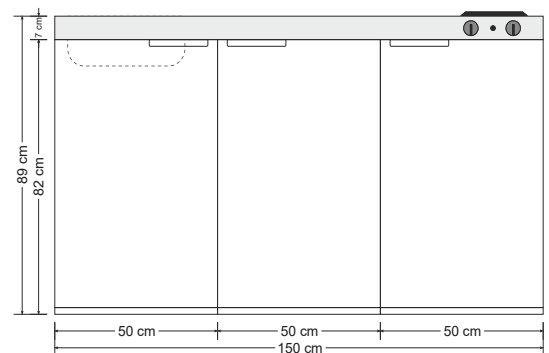
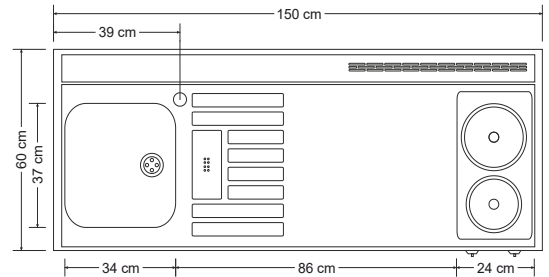

Colour Range Kitchenline

stainless steel



01 - stainless steel

gloss powder coating

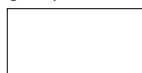

00 - white



03 - bordeaux



13 - green apple

matt powder coating



11 - sand



12 - black



14 - mocha metallic

structure
powder coating



15 - slate grey

article no.	colour	hob	bowlside
11150 000011 - XX		electric	bowl right
11150 000021 - XX		electric	bowl left
11150 000031 - XX		ceramic	bowl right
11150 000041 - XX		ceramic	bowl left
11150 000051 - XX		without	bowl right
11150 000061 - XX		without	bowl left

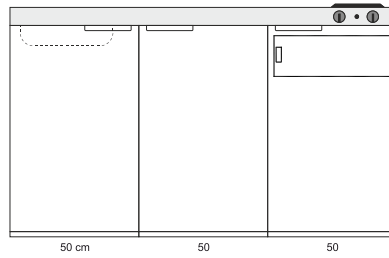

MK 150

fridge

dimensions: 150 x 60 x 89 cm (WxDxH)

article no.	colour	hob	bowlside
11150 010011 - XX		electric	bowl right
11150 010021 - XX		electric	bowl left
11150 010031 - XX		ceramic	bowl right
11150 010041 - XX		ceramic	bowl left
11150 010051 - XX		without	bowl right
11150 010061 - XX		without	bowl left

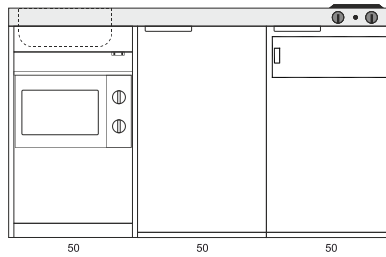

MKM 150

microwave, located behind the door
fridge

dimensions: 150 x 60 x 89 cm (WxDxH)

article no.	colour	hob	bowlside
11150 006011 - XX		electric	bowl right
11150 006021 - XX		electric	bowl left
11150 006031 - XX		ceramic	bowl right
11150 006041 - XX		ceramic	bowl left
11150 006051 - XX		without	bowl right
11150 006061 - XX		without	bowl left

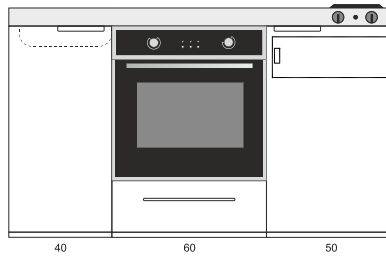

MKB 150

oven
fridge
one drawer

dimensions: 150 x 60 x 89 cm (WxDxH)

ME EASYLINE MINI KITCHEN

EASY AND FUNCTIONAL –
OUR ME EASYLINE

If less is more for you, then you have come to the right place. The Easyline models come with the impressive **Stengel** quality at an affordable price. All essential requirements – refrigerating, dish washing and cooking – are catered for

The **mini kitchen** made of powder-coated steel plate features double-walled doors with touch opening





Easyline ME

picture: ME100 with HSCL100

MINI KITCHEN EASYLINE 100CM ME 100

- › Fridge 2*-freezer
- › Pantry top in stainless steel, hob controls on the front, bowl, drain set, 35mm hole for tap, a choice of solid hotplates, ceramic hob or without hob
- › Metal cupboard 520mm unit in white powder coated finish. Door without handle - touch closure
- › There is a slight colour difference between fridge front and base structure
- › Available only in white
- › Available only including fridge
- › Delivered assembled and ready to plug in



picture: ME 100 with electric hotplates

ME 100

fridge

dimensions: 100 x 60 x 89 cm (WxDxH)

article no.	hob	bowlside
14100 000013 00	electric	bowl right
14100 000023 00	electric	bowl left
14100 000053 00	without	bowl right
14100 000063 00	without	bowl left

Top version

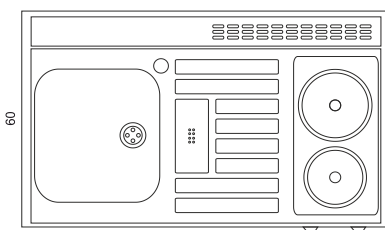

electric hotplates



without hob

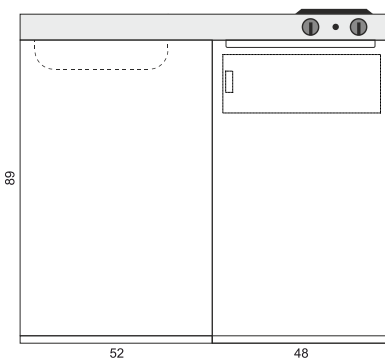

MINI KITCHEN EASYLINE 120CM ME 120

- › Fridge 2*-freezer
- › Pantry top in stainless steel, hob controls on the front, bowl, drain set, 35mm hole for tap, a choice of solid hotplates, ceramic hob or without hob
- › Metal cupboard 720mm unit with pelmet 200mm in white powder coated finish. Door without handle - touch closure
- › There is a slight colour difference between fridge front and base structure
- › Available only in white
- › Available only including fridge
- › Delivered assembled and ready to plug in



picture: ME 120 with electric hotplates

ME 120

fridge
cupboard 72cm with fix pelmet

dimensions: 120 x 60 x 89 cm (WxDxH)

article no.	hob	bowlside
14120 000013 00	electric	bowl right
14120 000023 00	electric	bowl left
14120 000053 00	without	bowl right
14120 000063 00	without	bowl left

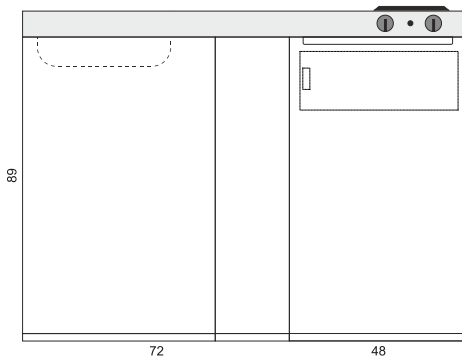
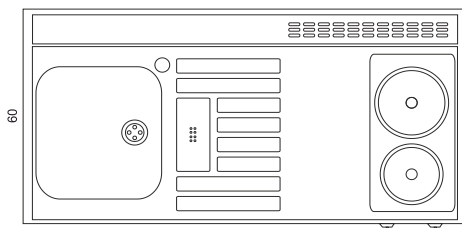

SL STUDIOLINE SET

Are you looking for something unique?
Would you like your **kitchen** free standing in a room?

The **Stengel Studioline** set offers a **mini kitchen** that meets all of these requirements.

We have developed the smallest **kitchen** with all functions and details that everyone needs and fits into the tightest of spaces.

A FREE STANDING MODULAR KITCHEN

Studioline is an ingenious system that links wall cupboards, splash backs and side panels to your chosen mini kitchen. The **Studioline** set gives you a complete kitchen solution that is compact, sleek and simple to install.





Studioline SL

picture: SID120 with MPM120A

STUDIOLINE

MODELS H2060

SLD - H2060

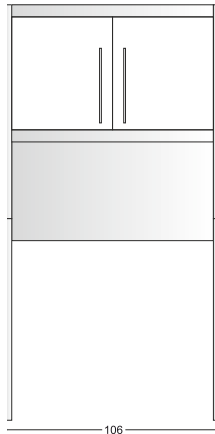
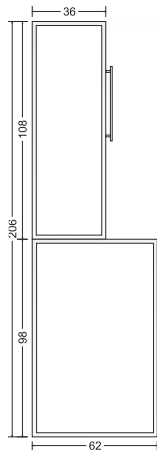

SLD 100 - H2060

article no. 13100 000000 - XX

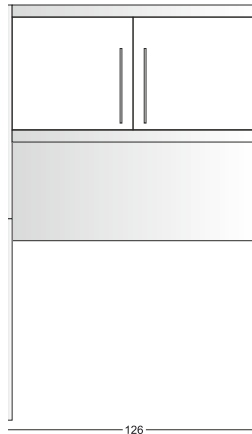

SLD 120 - H2060

13120 000000 - XX

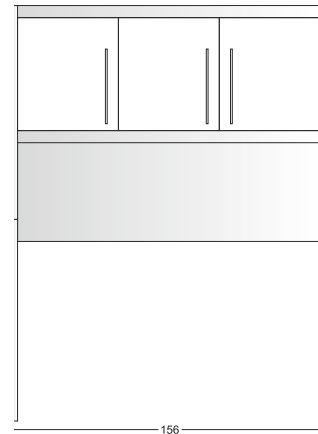

SLD 150 - H2060

13150 000000 - XX

Colour Range Studioline

stainless steel



01 - stainless steel

gloss powder coating



00 - white



03 - bordeaux



13 - green apple

matt powder coating



11 - sand



12 - black



14 - mocha metallic

structure powder coating



15 - slate grey

Modular system Studioline

- choose your mini kitchen to go with your selected Studioline



+



=



MODELS H2220

SLD - H2220

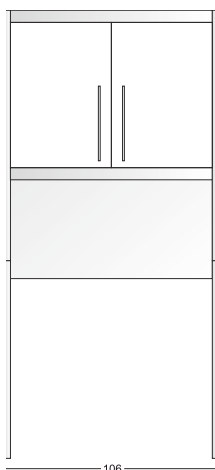
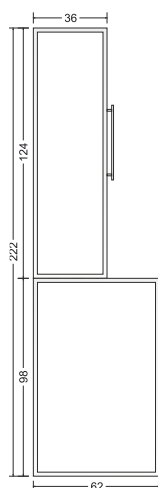

SLD 100 - H2220

article no. 13100 005000 - XX

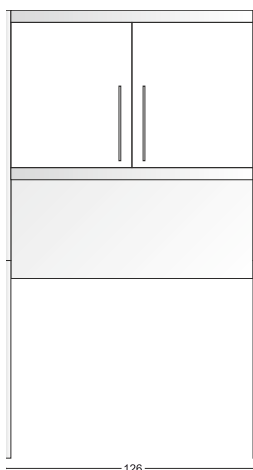

SLD 120 - H2220

13120 005000 - XX

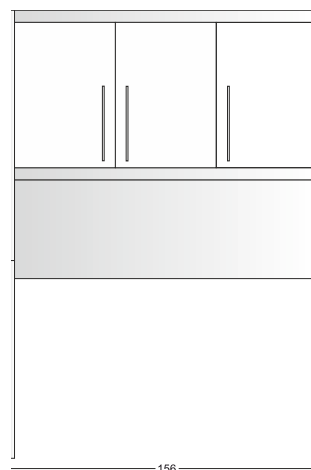

SLD 150 - H2220

13150 005000 - XX

SLDH - H2220 with extractor hood

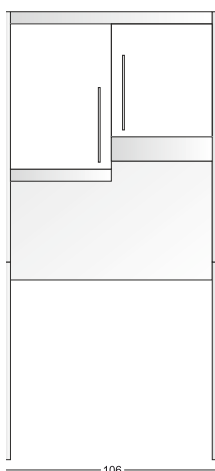
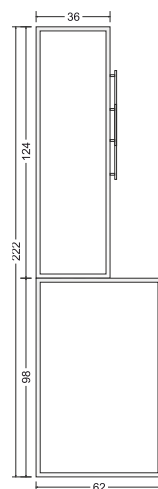

SLDH 100 - H2220

article no. 13100 106000 - XX - extractor-right

article no. 13100 206000 - XX - extractor-left

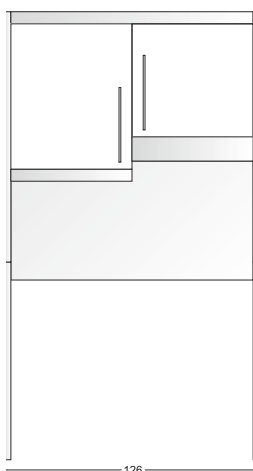

SLDH 120 - H2220

13120 106000 - XX - extractor-right

13120 206000 - XX - extractor-left

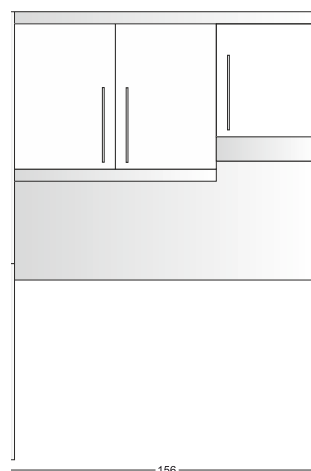

SLDH 150 - H2220

13150 106000 - XX - extractor-right

13150 206000 - XX - extractor-left

SLD STUDIO LINE

H2060 - H2220

- › New! Available in height of 206 cm und 222 cm
- › Double sided frame made from brushed stainless steel 1.4301, white powder coated infill panels
- › Self-supporting construction
- › Splashback made from brushed stainless steel 1.4301
- › Wall cupboard finished in powder coated metal, Filled double-walled fronts, powder-coated, bar handle in stainless steel, in height 56 cm and 72 cm
- › Upper and lower pelmets made from brushed stainless steel 1.4301
- › Available in 106, 126 and 156 cm width (for 100,120 and 150 mini kitchens)
- › Available in seven different colours
- › Only available in combination with a matching mini kitchen
- › Delivered in partially assembled condition with installation instruction





Studio line SL

picture: SLD150 with MP150
in colour mocha metallic

SLDH STUDIOLINE H2220 - WITH EXTRACTOR HOOD

- › Available height of 222 cm
- › Double sided frame made from brushed stainless steel 1.4301, white powder coated infill panels
- › Self-supporting construction
- › Inclusive extractor hood
- › Splashback made from brushed stainless steel 1.4301
- › Wall cupboard finished in powder coated metal, Filled double-walled fronts, powder-coated, bar handle in stainless steel, in height 56 cm and 72 cm
- › Upper and lower pelmets made from brushed stainless steel 1.4301
- › Available in 106, 126 and 156 cm width (for 100,120 and 150 mini kitchens)
- › Available in seven different colours
- › Only available in combination with a matching mini kitchen
- › Delivered in partially assembled condition with installation instruction





picture: SLDH150 with /MPGS150
in colour sand



SKM METAL CUPBOARD KITCHEN

STENGEL METALLIC CUPBOARD KITCHENS FASCINATE

Due to its contemporary design, our **Stengel Cupboard Kitchen** harmonically embeds itself into every environment. Even with closed front and perfect look, the cupboard kitchen offers all the benefits of a Stengel Steel Concept metal kitchen plus longevity of life compared to a wooden kitchen.

...open or closed – Metal with a lot of style and charm

Equip your basic model with electrical appliances and accessories that meet your demands. Easy-to-assemble and thus quickly ready for use.





CUPBOARD KITCHEN METAL

SKM 120 - BASIC MODEL

- › Metal cupboard unit in white powder coated finish
- › Double-walled doors and side parts with premium filling, bar handles in matt stainless steel
- › Doors with magnetic closures and safety shut-off for hob
- › Pantry top in stainless steel, including built-in bowl, drain set, 35mm hole for tap, a choice ceramic hob, induction hob or without hob
- › Heat dissipation of the electrical appliances is ensured by a ventilation level provided between the wall and the rear panel
- › Metal lower cupboard with drawer, compartment shelf and storage tray, depending on design and equipment
- › Two shelves, 1x fixed, 1x height-adjustable
- › Height-adjustable feet
- › Only available in colour white
- › Delivered assembled and ready to plug in



picture: SKM 120 - fully equipped

Please find advice for the connection of the SKM on page 82

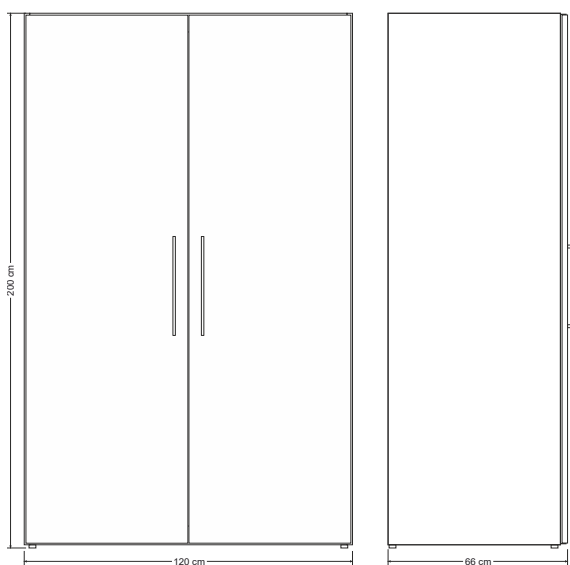

drawing: SKM 120 - measures

SKM 120 Basic model

cupboard, cabinet doors, 2x shelves, electrical outlet at the top, pantry top, under-sink structure with drawer and door, cupboard unit with door and compartment shelf

dimensions: W x D x H 120 x 66 x 200 cm

article no.	colour	hob	bowlside
15120 000030 00		ceramic	bowl right
15120 000040 00		ceramic	bowl left
15120 000050 00		without	bowl right
15120 000060 00		without	bowl left
15120 000070 00		induction	bowl right
15120 000080 00		induction	bowl left

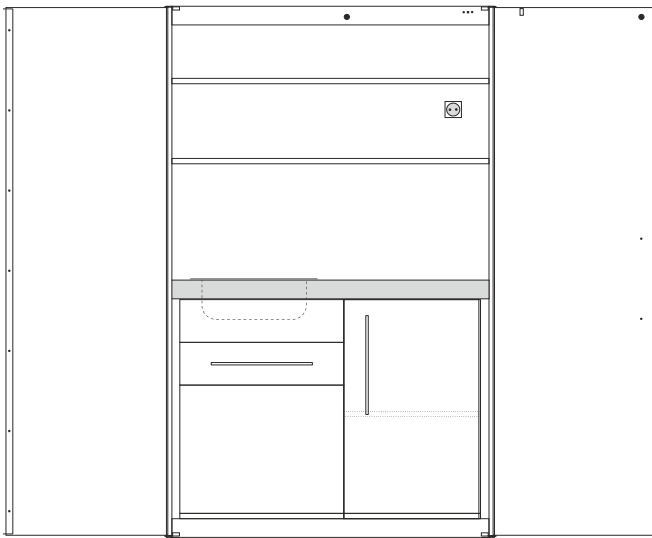

drawing: SKM 120 - Basic model without appliances

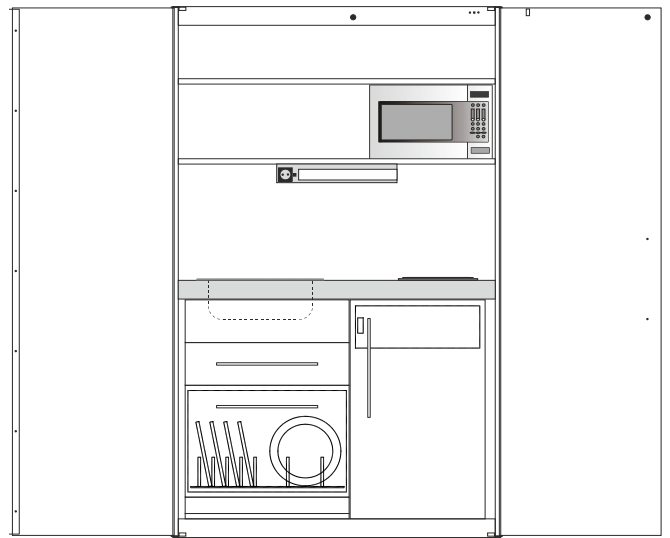

drawing: SKM 120 - Basic model - fully equipped

CUPBOARD KITCHEN METAL

SKM 120 - ACCESSORIES

Equip your cupboard kitchen with electrical appliances and accessories of your choice.

Please find additional information about the accessories starting of page 72

SKM 120

Accessories

article no.	description
15000 900001 00	fridge, 4* freezer, incl. mounting kit
15000 910000 00	dish-washer Stengel GS6-6FI2 - integrated, incl. mounting kit
15000 960000 00	microwave Stengel STCOMBI 101, incl. mounting kit
15000 950000 00	light strip LED 56cm - aluminum/stainless steel, with electrical outlets, installed
69001 000000 07	waste bin Cube 50 14+18 litre (not possible in combination with dishwasher!)
69005 000000 01	drawer 60 - Excellent II 600/50 - grey
60014 000000 00	one-handle mixer Kludi Scope - high pressure - chrome



CUPBOARD KITCHEN METAL

SKMG 60 - LARDER CUPBOARD

- > Suitable to our Stengel Cupboard Kitchen metal
- > Metal cupboard unit in white powder coated finish
- > Filled double-walled fronts and sides, powder-coated, bar handle in stainless steel
- > Five shelves, one fixed shelf and four adjustable shelves
- > Available only in white
- > Delivered assembled



picture: SKMG - larder cupboard 60cm

SKMG 60 Larder cupboard

dimensions: 60 x 60 x 200 cm (WxDxH)

article no.	description
15060 100001 00	door hinge right
15060 200001 00	door hinge left

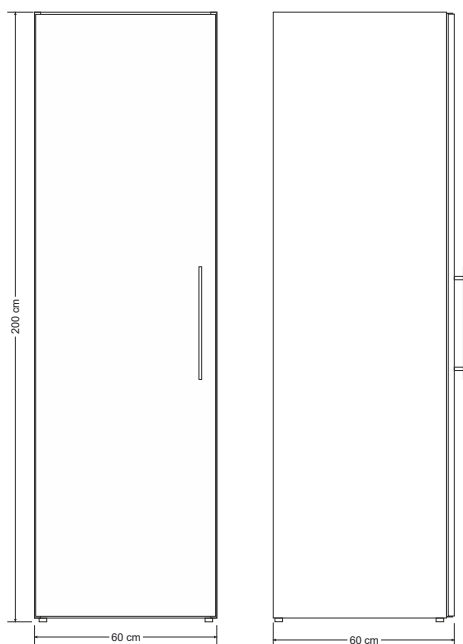

drawing: SKMG - larder cupboard 60cm

HS WALL CUPBOARDS

METAL

OUR WALL CUPBOARDS

THE PERFECT ADDITION TO COMPLIMENT YOUR
MINI KITCHEN

Premium with bar handle and Classic with hidden handle.
Increase the storage space in your kitchen by buying
a wall cupboard to match the size and style of kitchen
specified.

The doors are double walled with insulation to give
strength and a solid feel and the carcass made of powder
coated metal. Every wall cupboard is delivered pre-built.

Wall units are available in 560mm and 720mm height
and supplied with one or two height-adjustable shelves.
We provide a mounting rail for easy installation.

Our standard wall cupboards are available in white,
stainless steel and in colour.





Cupboards

WALL CUPBOARDS METAL

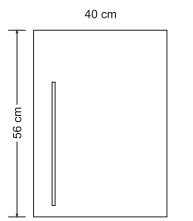

HS 40 - drawing

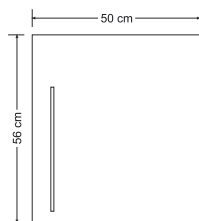

HS 50 - drawing

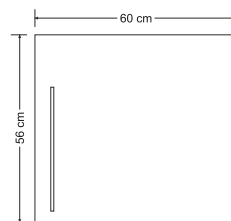

HS 60 - drawing

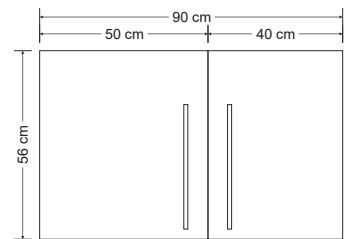

HS 90 - drawing



HS 40 - open



HS 50 - open



HS 60 - open



HS 90 - open

HSPL - Premium

BAR HANDLE

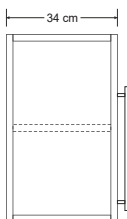

HSPL 40

article no. 30040 100001 - XX - DHR

article no. 30040 200001 - XX - DHL



HSPL 50

30050 100001 - XX - DHR

30050 200001 - XX - DHL



HSPL 60

30060 100001 - XX - DHR

30060 200001 - XX - DHL



HSPL 90

30090 100001 - XX - door 40cm DHR

30090 200001 - XX - door 40cm DHL

DHL = door hinge left · DHR = door hinge right

HSCL - Classic

HIDDEN HANDLE

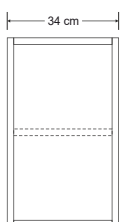

HSCL 40

article no. 30040 100002 - XX - DHR

article no. 30040 200002 - XX - DHL



HSCL 50

30050 100002 - XX - DHR

30050 200002 - XX - DHL



HSCL 60

30060 100002 - XX - DHR

30060 200002 - XX - DHL



HSCL 90

30090 100002 - XX - door 40cm DHR

30090 200002 - XX - door 40cm DHL

DHL = door hinge left · DHR = door hinge right

MODELS - H560

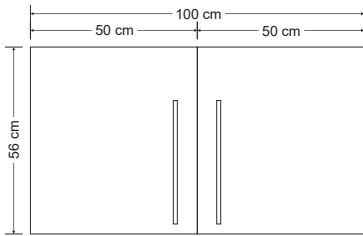

HS 100 - drawing

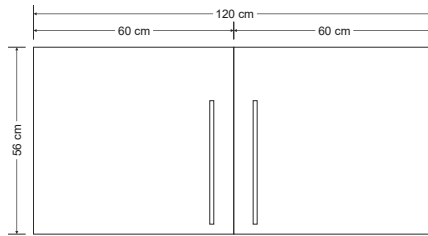

HS 120 - drawing

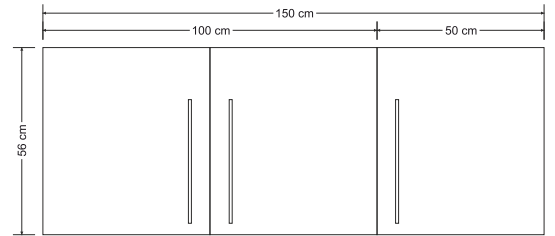

HS 150 - drawing



HS 100 - open



HS 120 - open



HS 150 - open

HSPL - Premium

BAR HANDLE



HSPL 100

article no. 30100 000001 - XX

article no.



HSPL 120

article no. 30120 000001 - XX



HSPL 150

article no. 30150 100001 - XX - 100/50 cm

article no. 30150 200001 - XX - 50/100 cm

HSCL - Classic

HIDDEN HANDLE



HSCL 100

article no. 30100 000002 - XX

article no.



HSCL 120

article no. 30120 000002 - XX



HSCL 150

article no. 30150 100002 - XX - 100/50 cm

article no. 30150 200002 - XX - 50/100 cm

WALL CUPBOARDS METAL

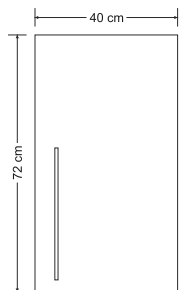

HS 40 - drawing

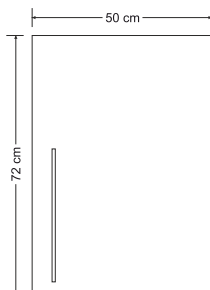

HS 50 - drawing

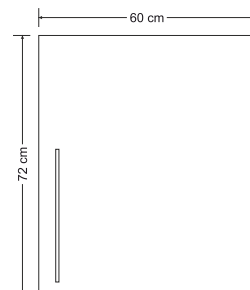

HS 60 - drawing



HS 40 - open



HS 50 - open



HS 60 - open

HSPL - Premium

BAR HANDLE

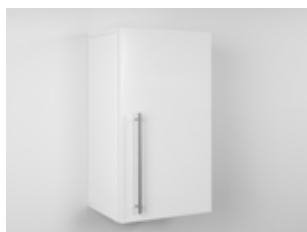
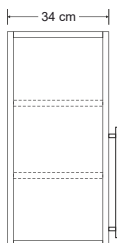

HSPL 40

article no. 30040 100101 - XX - DHR
article no. 30040 200101 - XX - DHL



HSPL 50

30050 100101 - XX - DHR
30050 200101 - XX - DHL



HSPL 60

30060 100101 - XX - DHR
30060 200101 - XX - DHL

DHL = door hinge left - DHR = door hinge right

HSCL - Classic

HIDDEN HANDLE

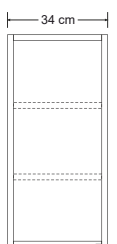

HSCL 40

article no. 30040 100102 - XX - DHR
article no. 30040 200102 - XX - DHL



HSCL 50

30050 100102 - XX - DHR
30050 200102 - XX - DHL



HSCL 60

30060 100102 - XX - DHR
30060 200102 - XX - DHL

DHL = door hinge left - DHR = door hinge right

MODELS - H720

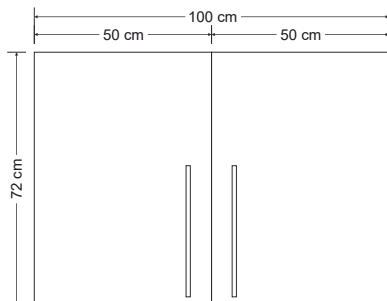

HS 100 - drawing

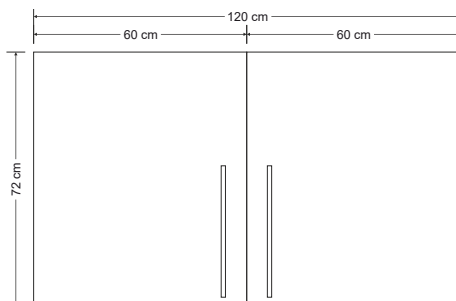

HS 120 - drawing



HS 100 - open



HS 120 - open

HSPL - Premium

BAR HANDLE



HSPL 100

article no. 30100 000101 - XX



HSPL 120

30120 000101 - XX

HSCL - Classic

HIDDEN HANDLE



HSCL 100

article no. 30100 000102 - XX



HSCL 120

30120 000102 - XX

Colour Range Premiumline

stainless steel



01 - stainless steel

gloss powder
coating



00 - white



03 - bordeaux



13 - green apple

mat powder
coating



11 - sand



12 - black



14 - mocha metallic

structure
powder coating



15 - slate grey

HS WALL CUPBOARDS WITH MICROWAVE

GET EVEN MORE INTO THE SMALLEST SPACE

This cupboard with integrated microwave significantly improves the possibilities to complement your **Stengel mini kitchen**.

The shelf on top offers additional storage space.

The clever design ensures an optional ventilation of the 20l microwave oven combination, that's why cupboard and microwave are always supplied as one unit.

The cupboard is finished either in white powder coated steel or in stainless steel, both these finishes match all ranges of **Stengel kitchens**. Available in white and stainless steel, and of course also in heights of 560 and 720mm.

All wall cupboards are delivered assembled.

HSMW - H560 **Wall cupboards with microwave height 56cm**

dimensions: W/D/H 60 x 36 x 56 cm

incl. microwave

article no.	description
30060 030000 00	wall cupboard with microwave 60 cm - white
30060 030000 01	wall cupboard with microwave 60 cm - stainless steel

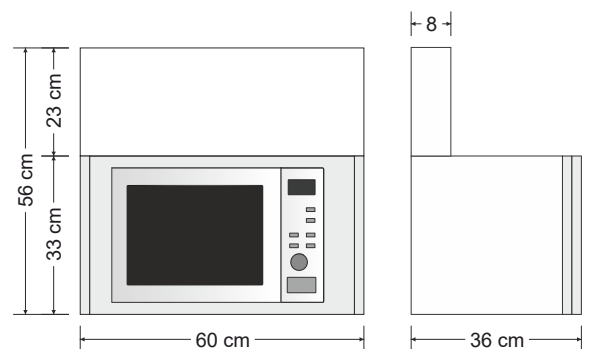

HSMW - H720 **Wall cupboards with microwave height 72cm**

dimensions: W/D/H 60 x 36 x 72 cm

incl. microwave

article no.	description
30060 040000 00	wall cupboard with microwave 60 cm - white
30060 040000 01	wall cupboard with microwave 60 cm - stainless steel

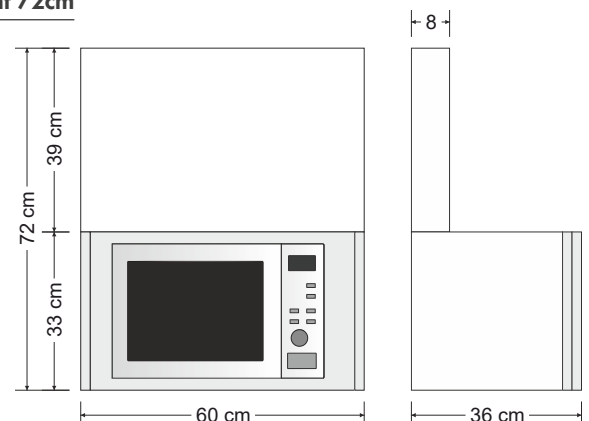



Cupboards

HO LARDER CUPBOARD

REALLY BIG STORAGE

Whether as addition to your kitchen or as addition to your apartment furniture - our tall cupboard offers not only offers enormous storage space, but also perfectly matches your minikitchen.

The doors and sides are double walled with insulation to give strengths and a solid feel and the carcass is made of powder coated metal. Every **HO - larder cupboard** is delivered with one fixed shelf and four adjustable shelves. The **HOB - larder cupboard** is equipped with an oven at a comfortable working height, there is a shelf behind each door.

Our standard tall cupboards are available in white or a choice of our colourrange.

All tall cupboards are delivered assembled.



drawing: HO - H2000/H2160

HOB - H2000

HO - H2000

Larder cupboard - 200cm

dimensions: W/D/H 60 x 60 x 200 cm

article no.	colour	description
34060 100001 - XX		larder cupboard 60 wide - metal - door hinge right
34060 200001 - XX		larder cupboard 60 wide - metal - door hinge left

HO - H2160

Larder cupboard - 216cm

dimensions: W/D/H 60 x 60 x 216 cm

article no.	colour	description
34060 100101 - XX		larder cupboard 60 wide - metal - door hinge right
34060 200101 - XX		larder cupboard 60 wide - metal - door hinge left

HOB - H2000

larder cupboard with oven

dimensions: W/D/H 60 x 60 x 200 cm

inclusive oven

article no.	colour	description
34060 106005 - XX		larder cupboard 60 wide - metal - door hinge right
34060 206005 - XX		larder cupboard 60 wide - metal - door hinge left



Colour Range Larder Cupboards

stainless steel



01 - stainless steel

gloss powder coating



00 - white



03 - bordeaux



13 - green apple

matt powder coating



11 - sand



12 - black



14 - mocha metallic

structure powder coating



15 - slate grey

WR WALL RACK

LIGHT AND FILIGREE - these shelves complement your mini kitchen.

Stylish space for this and that - our new shelves combine useful and practical.

SAND MATT
code 11

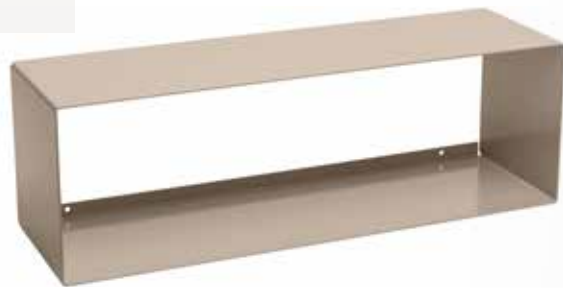

R-Slim

E-Slim

SLATE GREY
code 15



MOCHA METALLIC
code 14



BORDEAUX
code 03



WHITE
code 00



GREEN APPLE
code 13

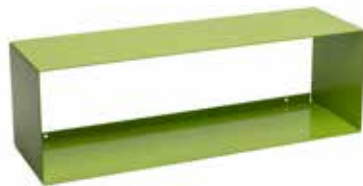

BLACK MATT
code 12





picture: wall rack with MPMOS160
in colour mocha metallic

Wall rack E-Slim and R-Slim

article no.	colour	description
69050 100000 - XX		wall rack E-Slim 50cm - edge shaped
69050 200000 - XX		wall rack R-Slim 50cm - round shaped

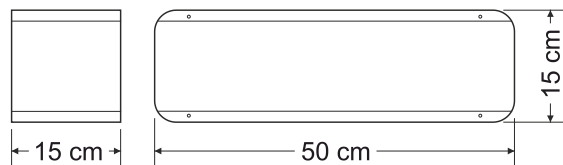

WALL TRIMS FOR PREMIUM KITCHENS

Wall trims allow you to create an extra 30mm space for installation behind the kitchen. They are made of 0.7mm 1.4301 stainless steel to perfectly match the stainless steel covers of our **Premiumline kitchens**. Wall trims are available in different widths 100 - 110 - 120 - 150 - 160 - 170 - 180 cm.



Wall trims stainless steel

article no.	dimensions: W x D x H 100 - 180 x 7 x 3 cm
63100 100000 01	100 cm wide
63110 100000 01	110 cm wide
63120 100000 01	120 cm wide
63150 100000 01	150 cm wide
63160 100000 01	160 cm wide
63170 100000 01	170 cm wide
63180 100000 01	180 cm wide



SPLASH BACKS & SIDE CHEEKS

STAINLESS STEEL

Our **stainless steel splash backs** and side cheeks are the perfect link between the kitchen base units and metal wall cupboards. They are made from quality 1,0 mm brushed stainless steel. **Splash backs** are available in different widths 90 - 100 - 110 - 120 - 150 - 160 - 170 - 180 cm.



Splash backs stainless steel

article no.	dimensions: W x D x H 90 - 180 x 55 x 1 cm
64090 000000 01	90 cm wide
64100 000000 01	100 cm wide
64110 000000 01	110 cm wide
64120 000000 01	120 cm wide
64150 000000 01	150 cm wide
64160 000000 01	160 cm wide
64170 000000 01	170 cm wide
64180 000000 01	180 cm wide

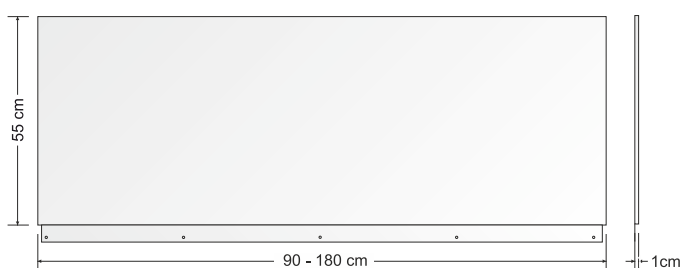

Side cheeks stainless steel

article no.	dimensions: W x D x H 90 - 59 x 55 x 1 cm
65059 000000 01	59 cm wide

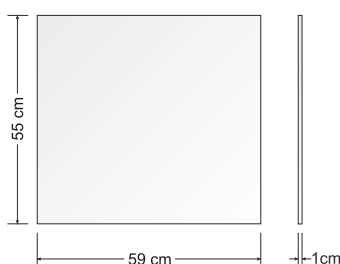

ACCESSORIES

FOR OUR MINI KITCHEN



article no. 69001 000000 02

Waste bin - CUBE 40

suitable to 40 cm cupboard
assembly system
two point waste separation

manual rails grey / black
two bins 14 litres
dimensions: 335 x 348 x 407 mm (WxHxD)



article no. 69001 000000 07

Waste bin - CUBE 50

article no. 69001 000000 05

suitable to 50 cm cupboard
assembly system
two point waste separation - bins 18 litre + 14 litres
three point waste separation - bins 2x8 litre + 14 litres

manual rails grey / black
dimensions: 438 x 345 x 330 mm (WxHxD)



article no. 69005 000000 04

Drawer organiser - Excellent II

article no. 69005 000000 00

article no. 69005 000000 01

article no. 69005 000000 03

colour grey
plastic material 2,5 mm

drawer organiser 40 dimensions: 330 x 50 x 440 mm (WxHxD)
drawer organiser 50 dimensions: 430 x 50 x 440 mm (WxHxD)
drawer organiser 60 dimensions: 530 x 50 x 440 mm (WxHxD)
drawer organiser 70 dimensions: 630 x 50 x 440 mm (WxHxD)



article no. 62040 000000 00

article no. 62050 000000 00

article no. 62060 000000 00

article no. 62070 000000 00

Shelf - metal for minikitchen

shelf for base units including fixings
metal powder coated white pre-cut holes for one shelf per cupboard unit!

model 40 cm white metal finish

model 50 cm white metal finish

model 60 cm white metal finish

model 70 cm white metal finish



article no. 69007 000000 02

Tray - for pull-out-unit 20cm

suitable for the pull-out-unit 20cm (from 2022) width 20cm
colour grey / powder coated dimensions: 100 x 400 x 450mm (WxHxD)



article no. 69009 000000 00

Cutting board - glas

suitable to sink Line 60
weight 650 g
safety glas

dimensions: 355 x 215 x 12 mm (WxDxH)



article no. 69010 000000 00 **Cutting board - wood**

suitable to sink Line 60

beech wood

weight 1270 g

dimensions: 360 x 220 x 25 mm (WxDxH)



article no. 69011 000000 00 **Draining basin RSF - stainless steel**

suitable to sink Line 60

weight 545 g

stainless steel

dimensions: 171 x 360 x 75 mm (WxDxH)

TAPS



All **KLUDI** taps offer the following added values:

Flow class A - noise group I - rapid installation set - flexible connecting hose G 3/8 - ceramic cartridge with hot water safety device - 5 years guarantee - after sales service



One-handle mixer - Kludi Scope

DN 10, chrome, for 35 mm tap hole, rotatable 360°

article no. 60013 000000 00

low pressure

article no. 60014 000000 00

high pressure



One-handle mixer - Kludi Zenta

DN 10, chrome, for 35 mm tap hole, rotatable 360°

article no. 60016 000000 00

high pressure



One-handle mixer - Bingo Star

DN 10, chrome, for 35 mm tap hole, rotatable 360°

article no. 60017 000000 00

high pressure



One-handle mixer - Kludi L-line S

DN 10, chrome, for 35 mm tap hole, rotatable 360°

article no. 60018 000000 00

high pressure



One-handle mixer - Kludi Steel - stainless steel

DN 10, brushed stainless steel, for 35 mm tap hole, rotatable 360°

article no. 60022 000000 00

high pressure

ELECTRICAL EQUIPMENT

FOR OUR MINI KITCHEN



article no. 46005 000000 00 **Fridge - Stengel KS 5002 EU**

capacity gross 114 litres	4* freezer / EEF- Class E
capacity net 100 litres	automatic defrosting system
freezer compartment 14 litres	connection 220 - 240 V / 50 Hz
sound level 41dB (A) - C	climate class ST/N (10°-38°C)
weight 27,50 kg	cooling agent R 600 A / FCKW-free
LED - Interior lighting	dimensions: 820 x 497 x 579 mm (HxWxD)



article no. 46004 000000 00 **Fridge - Stengel KU 1102**

capacity gross 82 litres	2* freezer / EEF- Class E
capacity net 74 litres	energy consumption 106,0 kW / Jahr
freezer compartment 8 litres	connection 220 - 240 V / 50 Hz
sound level 41dB (A) - C	climate class T/N (16°-43°C)
weight 22,5 kg	cooling agent R 600 A / FCKW-free
LED - Interior lighting	dimensions: 820 x 480 x 560 mm (HxWxD)



article no. 42004 000000 00 **Microwave - Amica MW 13150 W**

30 minute timer manual volume 17 Liter	
defrosting program	microwave 700 W / 6 levels
glass plate Ø245mm	connection 220-240 V / 50 Hz - 1200 W
weight 10,5 kg	dimensions: 262 x 452 x 335 mm (HxWxD)



article no. 42010 000000 00 **Microwave - Stengel STCOMBI101 - 20I**

stainless steel front	volume 20 litres
turntable system	microwave 800 Watt
automatic programs	grill 1200 Watt
child-safety lock	heating air / oven 2200W
glass plate Ø245mm	connection: 230 - 240 V / 50 Hz
weight 14,4 kg	dimensions: 262 x 452 x 360 mm (HxWxD)



article no. 42011 000000 00 **Microwave combination - Russell hobbs RHM3003 - 30I**

combination oven / microwave	volume 30 litres
glass plate	microwave 1450 W
automatic programs	grill 1100 W
child-safety lock	heating air / oven 2500 Watt
	connection: 230 - 240 V / 50 Hz
weight 19,9 kg	dimensions: 335 x 520 x 510 mm (HxWxD)

You can find data sheets for our electrical appliances here:

www.minikuechen.de/download



article no. 69001 000000 01 **Timer - for minikitchen Kitchenline / Easyline**

fits in all MK Kitchenline and Easyline models (90, 100, 120 and 150 cm)
2-pole switch up to 30 minutes,
16 A / till 250 V



article no. 44003 000000 00 **Oven - Stengel EBO9.3X**

9 programs	power 3000 W
energy label A	energy use 0,91 kW/h
volume 76 litres	connection 220-240V/50 Hz - 3000 W
weight 35,0 kg	dimensions: 595 x 595 x 575 mm (WxHxD)



article no. 41012 000000 00 **Dishwasher - Stengel GS6-6FI2 - integrated**

built-in unit	drying index 1,07
water consumption 6,5 litres	EEF- class F
6 programs	energy consumption Eco 0,610 kW/h
temperatures 40 - 60°C	acoustic level 49 dB
6 rinse cycles	connection: 230V / 50 Hz - 1170-1380 W
weight 20 kg	dimensions: 438 x 550 x 500 mm (HxWxD)



article no. 43008 000000 00 **Double ceramic hob - Stengel EB-GK2-TC**

touch control	high-speed plate Ø145 mm / 1200 W
9 heating levels each plate	high-speed plate Ø180 mm / 1800 W
timer	250 cm cable with angle plug
residual heat indicator	connection: 220 - 240 V / 50 Hz - 3000 W
	dimensions: 288 x 53 x 520 mm (WxHxD)



article no. 43006 000000 00 **Double induction hob - CASO - Master E2**

double induction hob	child-safety lock / overheat protection
touch control	power level 3500 W (1500 / 2000 W)
timer 1 - 99 min	250 cm cable with angle plug
9 heating levels each plate	connection: 230 V / 50 Hz
approved by GS, CE	dimensions: 289 x 56 x 520 mm (WxHxD)

ELECTRICAL EQUIPMENT

FOR OUR MINI KITCHEN

You can find data sheets for our electrical appliances here:
www.minikuechen.de/download



article no. 45017 000000 00

article no. 45018 000000 00

Extractor hood - Wiggo WE-E513G/WE613G

3 speed levels	touch control
connection tube 120 mm	
lightning 2x 1W LED	acoustic level 63 dBA
weight 6,4 / 6,7 kg	exhaust air max. 300 m ³ / h
EEF-class D	connection: 230 V / 50 Hz - 100W

WE-E513G - width 50 cm - black glass - dim: 495x373x772-877 mm (WxDxH)

WE-E613G - width 60 cm - black glass - dim: 595x373x772-877 mm (WxDxH)



article no. 45007 000000 00

Extractor hood - Amica UH 17052-3-E - 50cm

connection tube 125 mm	3 speed levels 105-173 m ³ / h
lighting LED 4W	acoustic level 52 - 63 dBA
weight 3,9 kg / cable 140cm	connection: 230 V / 50 Hz - 90W
EEF-class C	dimensions: 500 x 505 x 130 mm (WxDxH)



article no. 45013 000000 00

Extractor hood - Amica UH 17010-4-E - 60cm

connection tube 125 mm	3 speed levels 110-178 m ³ / h
lighting LED 4W	acoustic level 53 - max. 63 dBA
weight 4,5 kg / cable 140 cm	connection: 230 V / 50 Hz - 90W
EEF-class C	dimensions: 600 x 505 x 130 mm (WxDxH)



article no. 47003 000000 00

Water heater - Dimplex ACK 5 U

5 Liter Volumen, depressurised	class A
wall mounting	
water temperature 35 - 85°C	connection: 230 V / 50 Hz - 2000W
degree of protection IP24	protection class I splash-proof
weight 3,5 kg	dimensions: 256 x 213 x 390 mm (WxDxH)



article no. 47007 000000 00

Light strip LED - alu / stainless steel with 2 sockets

LED - light strip with switch	housing in aluminum/stainless steel
2 sockets	connection: 230 V / 50 Hz
light colour 4000 K white	644 lumen - 6,5 W
	dimensions: 560 x 71 x 71 mm (WxDxH)

COMPANY

Stengel Steel Concept GmbH

Based in Ellwangen/Baden Württemberg **Stengel Steel Concept** was established in 2016 from **Stengel Küchen GmbH**, which had been founded in 2011. This change was a result of expansions and innovations made possible by the material metal. Being a subsidiary of **Stengel GmbH**, we have all techniques and options offered by metal processing at our disposal while the Stengel Steel Concept GmbH benefits of its own design and production areas.

Stengel GmbH

Stengel GmbH is a medium sized family owned company with more than 40 years of experience in sheet metal production.

With more than 850 employees, approximately 108.000 m² of production and storage area, our own powder coating facility and state of the art machinery, **Stengel GmbH** is able to meet the demands of today's market. As well as a large range of mini kitchens Stengel GmbH manufactures more than 50.000 products, including wet room units for cruise liners and building construction, server cabinets, office furniture, shop displays and many more products for well-known companies throughout Europe.

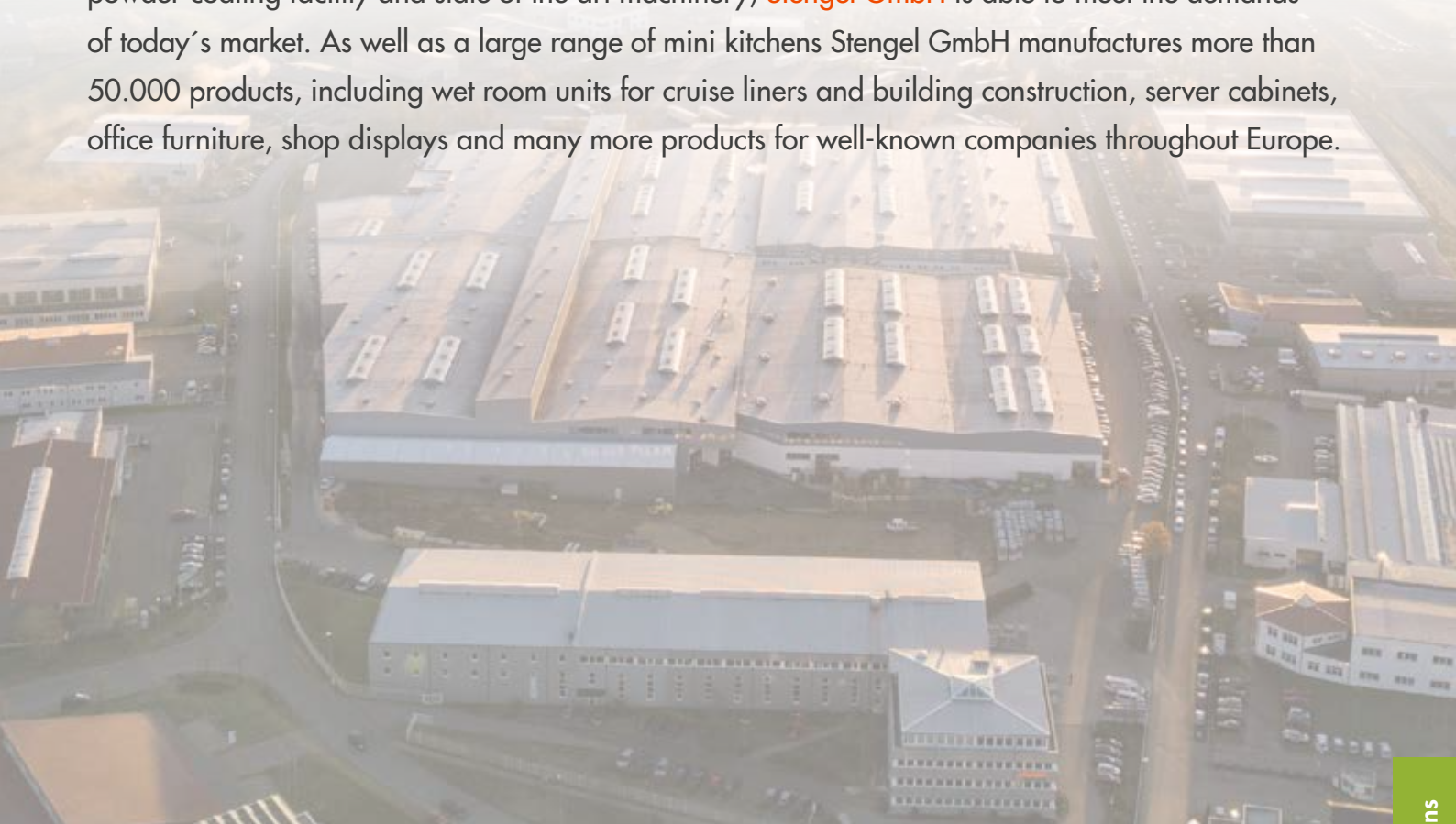

PROJECTS

Stengel kitchens are already used in many projects throughout Europe.

They have proven their many advantages like high durability, high quality material, low installation costs, low maintenance costs and a timeless style in environments including student accommodation, hotels, holiday and retirement homes.

Our experience for your project.

We advise and work closely with our clients including architects and planning agencies in all aspects from design to completion. Thanks to our wealth of experience in special project work we are able to meet your exacting requirements. Our design team pride themselves on helping our clients meet their specification, budgets and timelines in a professional and helpful way.

Numerous references at home and abroad provide prove of our quality and performance in the project. You can find further information on our homepage.





DELIVERY

FOR OUR MINIKITCHENS

We ensure fast and reliable delivery.



PACKAGING

All **kitchen** models are specially packed to reduce damage and delivered on pallets for easy handling on site.

Electric appliances that are not integrated in the kitchens such as ovens, microwaves or dishwashers, are delivered with the kitchen and securely fastened.

OUR LOGISTICS- AND SERVICE PARTNERS

stengel

STENGEL GMBH

DACHSER
Intelligent Logistics



 **SPEDITION
PFLEIDERER**
MÖBELLOGISTIK IN PERFEKTION

CONNECTION - SCHEME

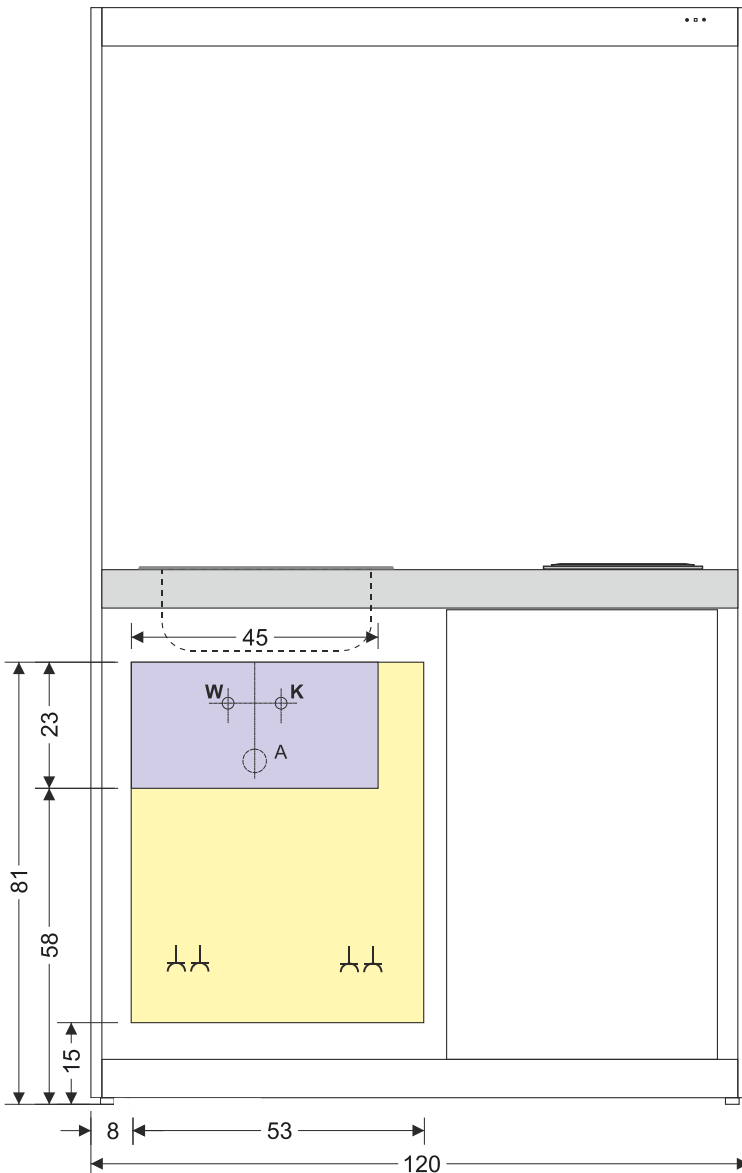
CUPBOARD KITCHEN SKM



Information:

-  = Recommended area for water connections
-  = Recommended area for electrical connections

 = Outlets 230V upon quantity of el. circuits within the bounds of the installation area

H = Hot water connection

C = Cold water connection

A = Waste water connection

Scheme is connection advice. Modifications according upon structural conditions are possible.

Integrated safety switch (door switch-off):
1x 16 A for hob upon 3500W
1x 16 A for microwave/ light
(1 socket per circuit)

Direct circuit (without door switch):
1x 16 A for fridge/ dishwasher
(1 socket per appliances)



Important notice!!!

Figure with hotplates right bowl left. Please check before installation, which side of hotplates or bowl you have and install plugs reverse left to right accordingly.

Subsequent complaints are not accepted!

We recommend the installation of your kitchen by a plumbing or electrical specialist

CONNECTION SCHEME

MINIKITCHEN MP - MK - ME

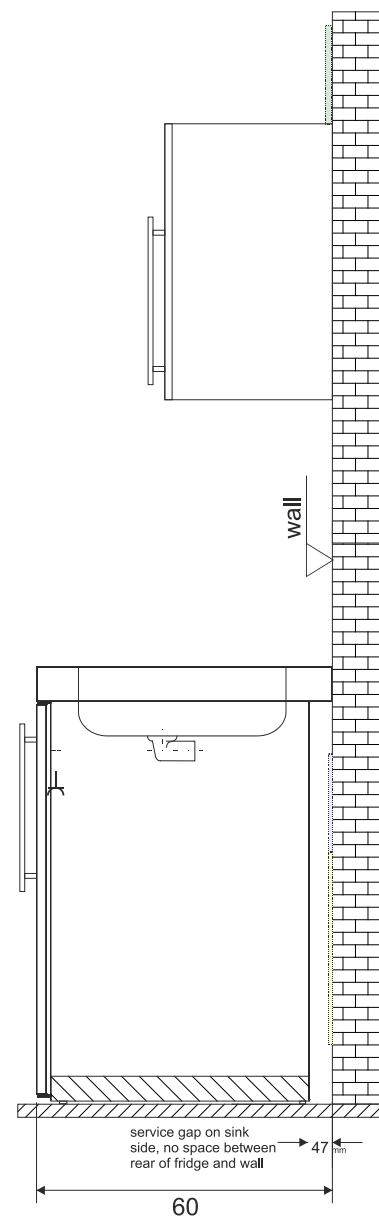
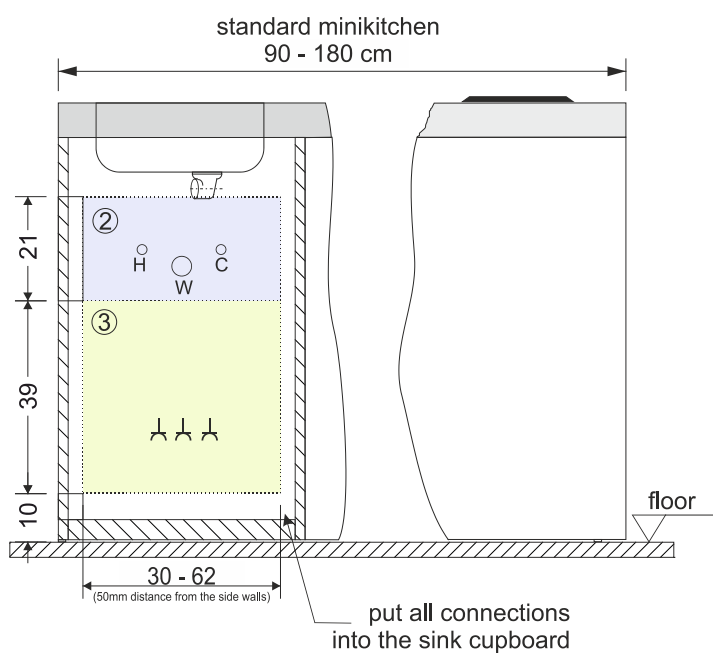
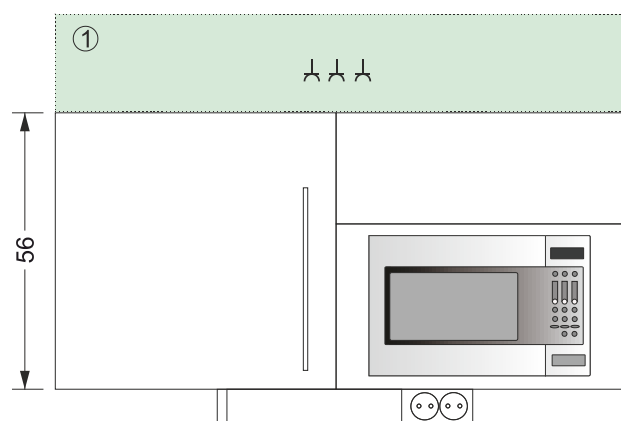

- ① Recommended area for electrical connections of wall cupboards (e.g. microwave, light strip, extractor hood etc.)
- ② Recommended area for water connections
- ③ Recommended area for electrical connections for mini kitchen (e.g. fridge, microwave, dishwasher, oven etc.)

Distances in the installation area:

- wall - drawer	=	130 mm
- wall - dishwasher	=	65 mm
- wall - 4* fridge Stengel (MK / MP / MO)	=	15-18 mm
- wall - 2* fridge Stengel (ME)	=	50 mm
- wall - microwave 20l	=	240-280 mm
- wall - micro-oven 30l	=	100 mm
- wall - oven	=	25 mm
- wall - shelf	=	50 mm

- Bases of the mini kitchens are delivered without rear panel
- Quantity of outlets according to quantity of electrical appliances
- All electrical appliances are 230V operated-
- Performance data of electrical appliances, see data sheets or current catalogue



Stengel Steel Concept GmbH

Wilhelm-Maybach-Str. 1-3

73479 Ellwangen

Germany

phone: +49 7961 9121 - 400

email: office@stengel-steelconcept.com

www.stengel-steelconcept.com



stengel 
steel concept